



SFS

**Adjustable
window
mounting
fasteners
SPTR-V**

A new range, a new concept

The new range of adjustable SPTR-V window mounting screws from SFS is the ideal solution for all frame and support materials. Available in 2 versions, the SPTR-V6 and SPTR-V8 fasteners allows you to meet all your needs concerning frame installations, either new or renovation. This new concept has been designed, developed and patented to improve performance and great fixation. Versatility, performance and confort characterize the SPTR-V range.

For all types of frames

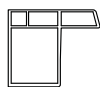

PVC

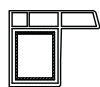

Reinforced
uPVC

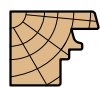

Wood



Aluminum

For all type of support material



Wood



Concrete



Hollow brick



Frame stability thanks to the guidance zone



Optimized torque transmission thanks to T30 screw head



Nice head shape and aesthetic colors



Tilted installation up to +/- 5° possible

SPTR-V6

For installation in wood

- 60 mm
- 70 mm
- 80 mm
- 100 mm



100 mm

SPTR-V8

For installation in concrete and brickwork

- 95 mm
- 105 mm
- 120 mm
- 150 mm



150 mm



The SPTR-V range is protected by European patent®, in conformity with the general conditions of implementation of joinery. CSTB recommend the product range in France. www.cstb.fr/en

SPTR-V6 : for installation in wood support

The SPTR-V6 is a new fastener that allows an easy installation of high quality. It offers the possibility to adjust and align perfectly the frame during installation. The SPTR-V6 adjustable mounting screw is available in 4 lengths, from 60 to 100 mm to cover all applications. Choose the proper length depending on the thickness of your frame.

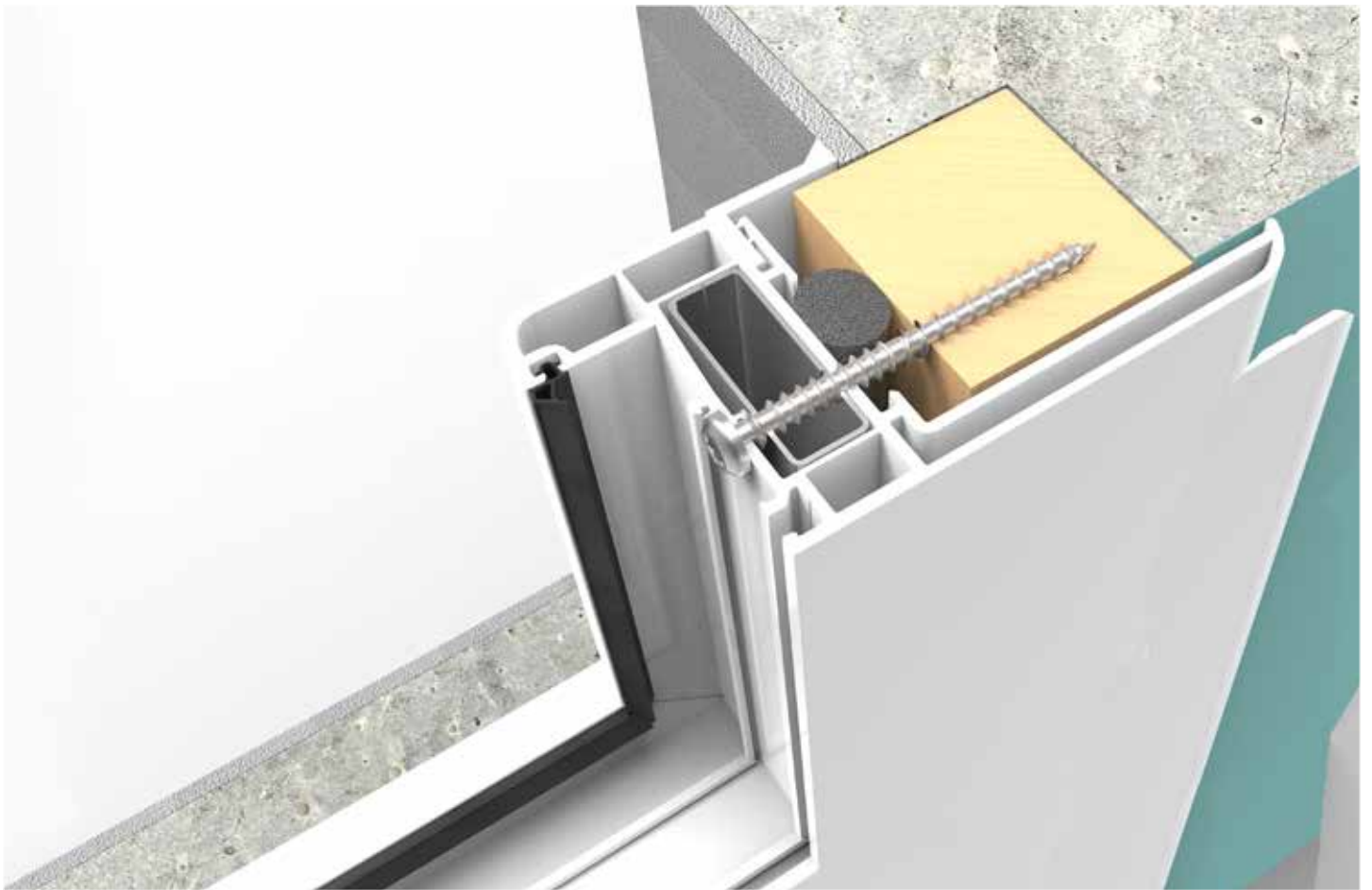

Scan this QR code to view the video of the SPTR-V6 range

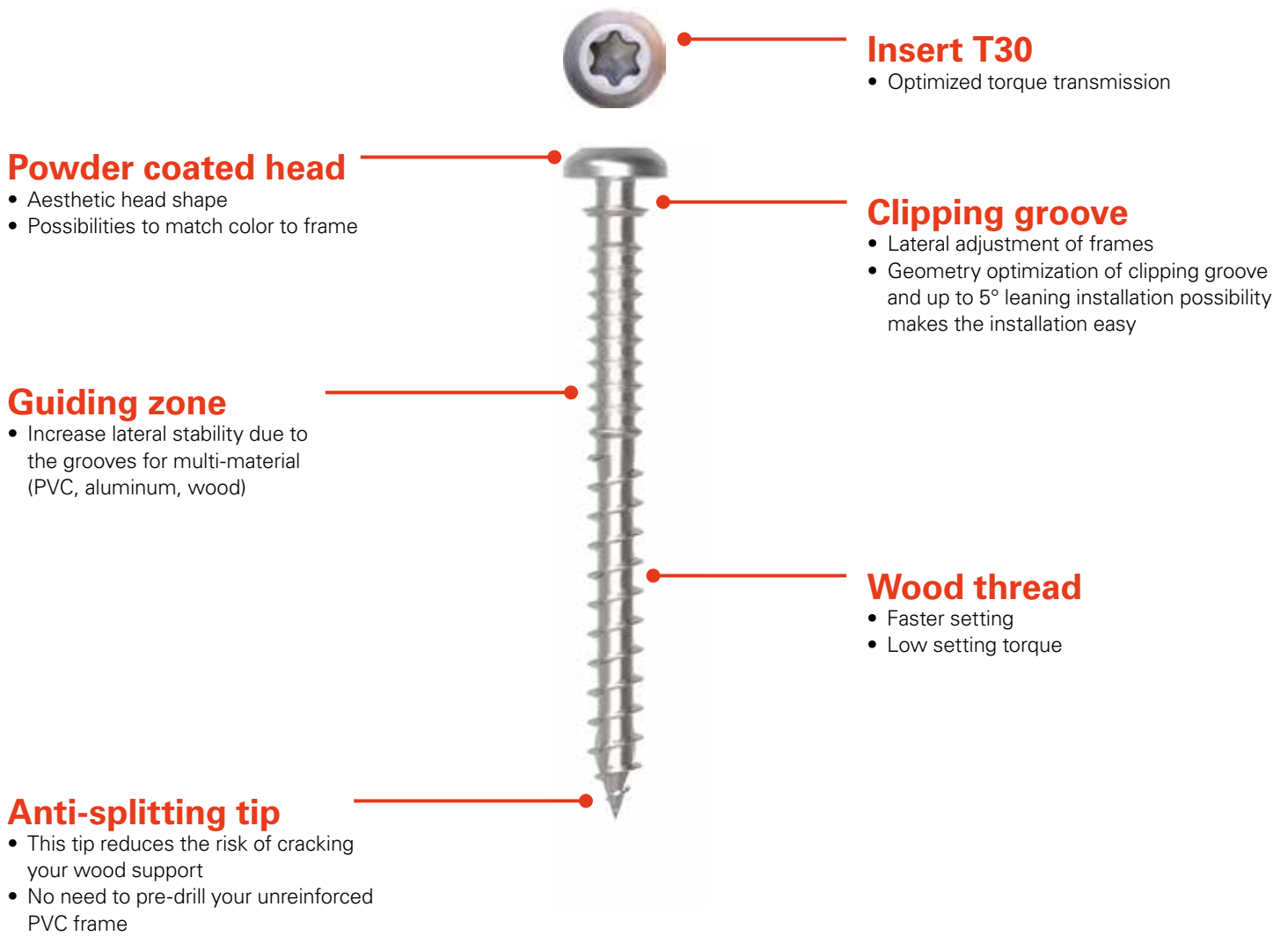

Applications

PVC frame - Wood support

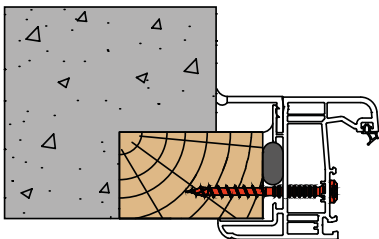

Steel Reinforced PVC frame - Wood Support

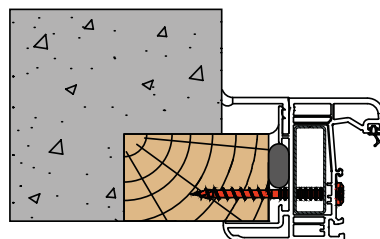

Wood frame - Wood support

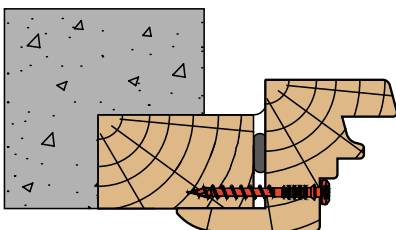

Aluminum frame - Wood Support

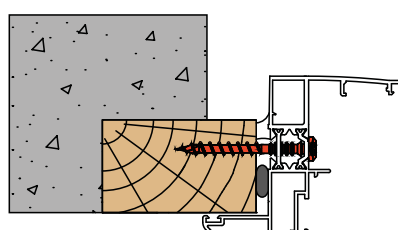

SPTR-V8 : frame installation into masonry support

The SPTR-V8 revolutionizes installations whether in new or renovation. It allows perfect adjustment and alignment of frame during installation. Available in 4 lengths, it has been studied to meet all applications on the market. Choose a length depending on the thickness of your frame.

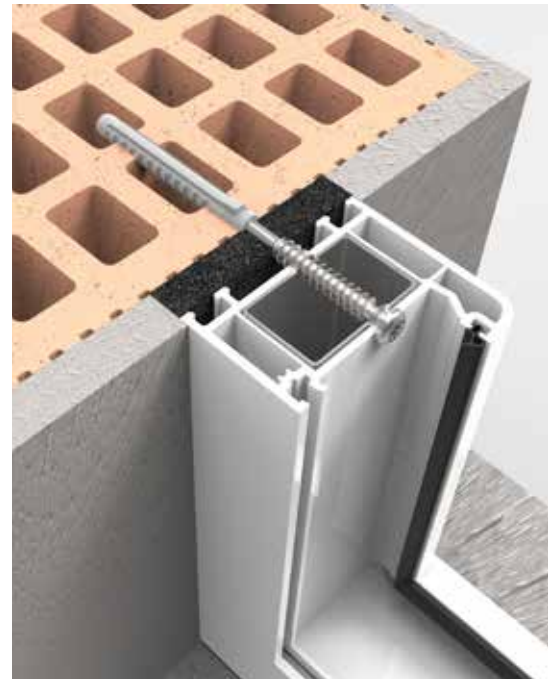

Scan this QR code to view the video of the SPTR-V8 range

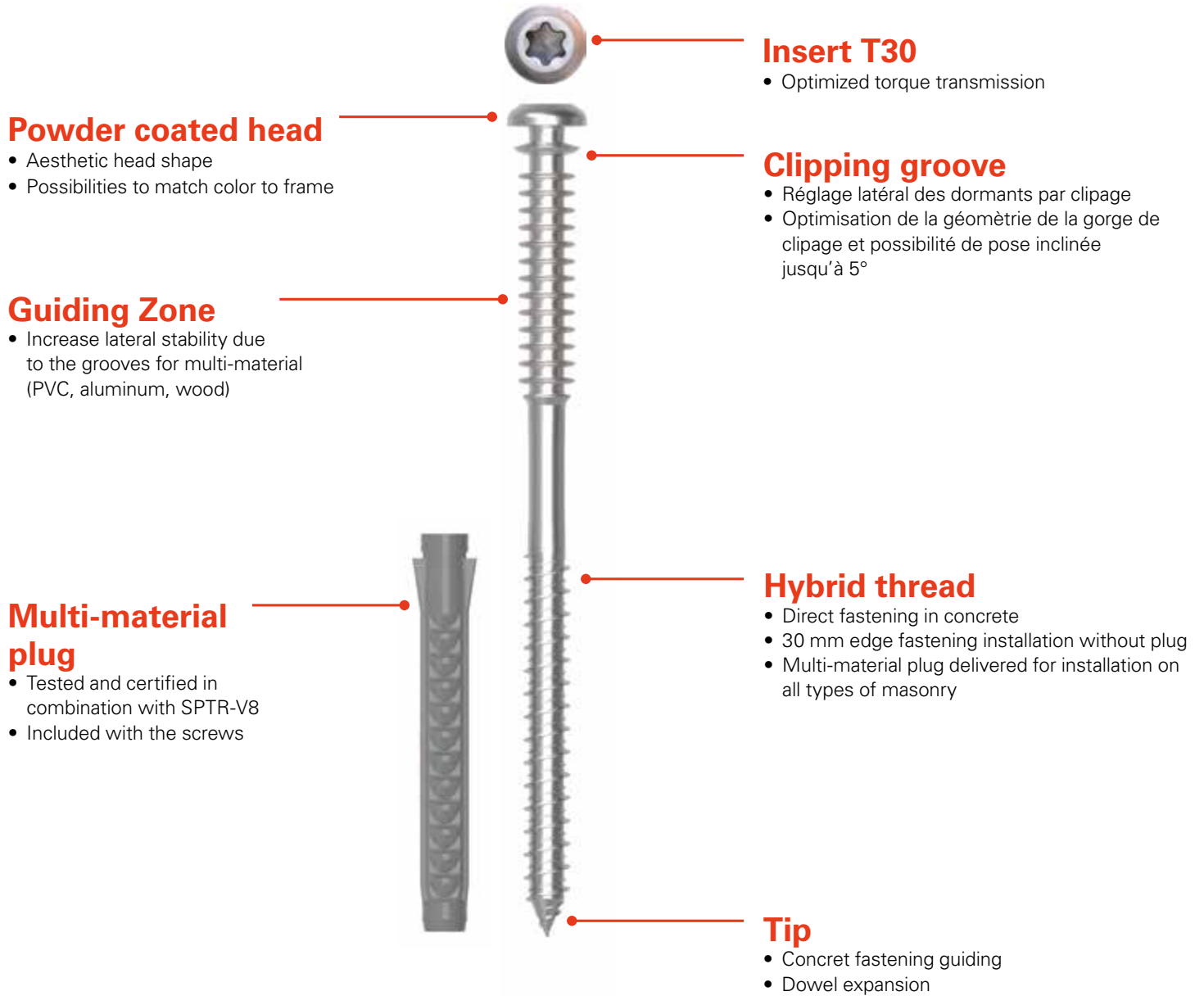

Applications

Aluminum frame - Concrete support

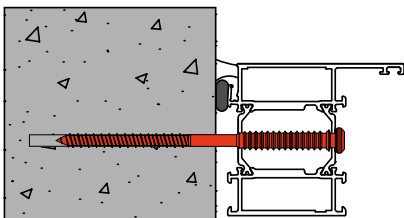

Wooden frame - Brick support

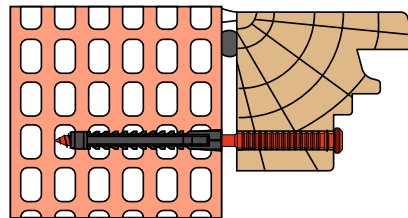



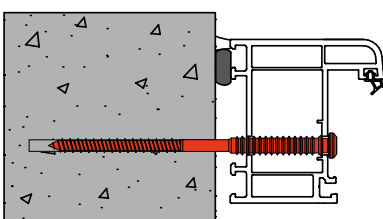

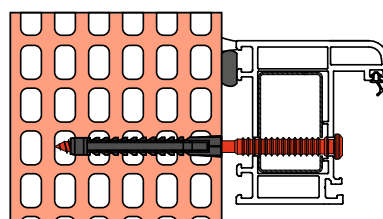

PVC frame - Concrete support



Reinforced PVC frame - Brick support



Installation recommendations

		SPTR-V6	SPTR-V8
Type of frame	 PVC	Optional pre-drilling	Ø 8 mm Pre-drilling
	 Reinforced PVC	Ø 6 mm Pre-drilling	Ø 8 mm Pre-drilling
	 Aluminum	Ø 5 mm Pre-drilling	Ø 8 mm Pre-drilling
	 Wood	Ø 4 mm Pre-drilling	Ø 7 mm Pre-drilling
Support	 Wood	No pre-drilling	-
	 Concrete	-	Direct installation : 5,2 / 5.5 mm (soft/hard) Installation with plug : Ø 8 mm
	 Brick	-	Ø 8 mm Pre-drilling

Installation

SPTR-V6

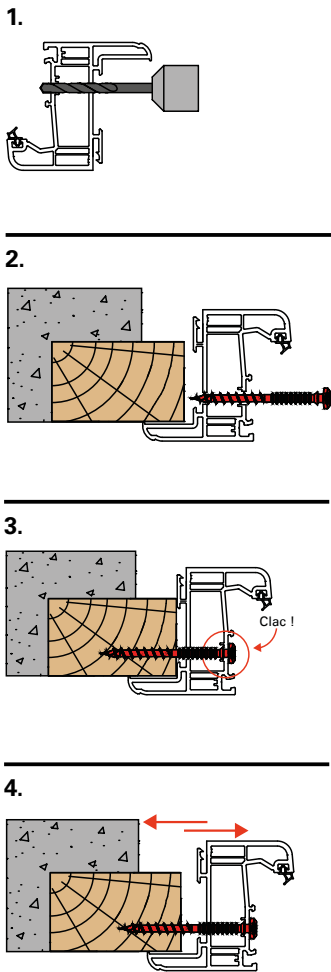

SPTR-V8

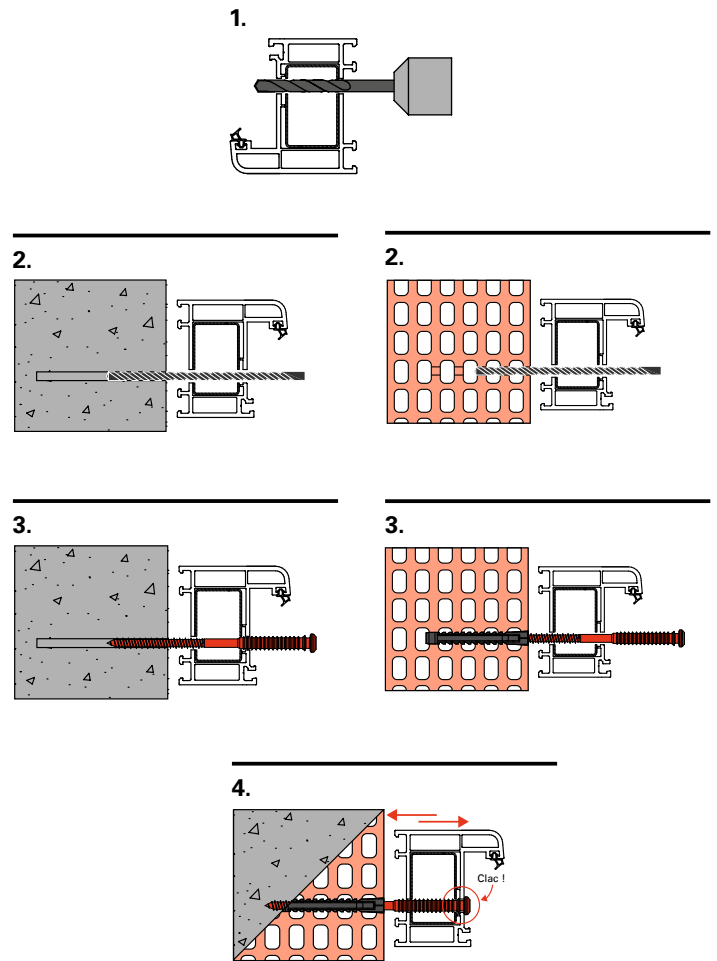

Product Range



Installation: wooden support

SPTR-V6

Code	Article code						
	White RAL9016	Black RAL9005	Beige RAL1015	Anthracite Grey RAL7016	Grey RAL7035	Golden Oak RAL8003	Brown RAL8017
SPTR-V6/15-T30-6 x 60	1553854	1553855	1553856	1553857	1553873	1553874	1553875
SPTR-V6/25-T30-6 x 70	1550281	1553810	1553824	1553827	1553851	1553852	1553853
SPTR-V6/35-T30-6 x 80	1553880	1553881	1553883	1553894	1553897	1553898	1553899
SPTR-V6/45-T30-6 x 100	1553910	1553912	1553918	1553919	1553920	1553931	1553932

Quantity/box : 100 pieces

Installation tools

	Product	Quantity/Package	Article Code
T30 bits	T30-50-HEX1/4"	10	24046
	T30-70-HEX1/4"		23488
	T30-90-HEX1/4"		654613
HSS drills	HSS-5,0X132/87	1	528711
	HSS-6,0X139/91		1046369
	HSS-8X0X165/109		1027435

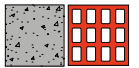

Installation: masonry support

SPTR-V8

	Article code						
	White RAL9016	Black RAL9005	Beige RAL1015	Anthracite Grey RAL7016	Grey RAL7035	Golden Oak RAL8003	Brown RAL8017
SPTR-V8/17-T30-6,3 x 95 incl. 8 x 65 plug	1572964	1572965	1572966	1572967	1572968	1572969	1572970
SPTR-V8/26-T30-6,3 x 105 incl. 8 x 65 plug	1555007	1555008	1555009	1555010	1555011	1555012	1555013
SPTR-V8/37-T30-6,3 x 120 incl. 8 x 65 plug	1562141	1562142	1562143	1562144	1562145	1562146	1562147
SPTR-V8/50-T30-6,3 x 150 incl. 8 x 65 plug	1564522	1564523	1564524	1564525	1564527	1564528	1564529

Quantity/box : 100 pieces

Installation tools

	Product	Quantity/Package	Article Code
T30 bits	T30-50-HEX1/4"	10	24046
	T30-70-HEX1/4"		23488
	T30-90-HEX1/4"		654613
Concrete drills - SDS fitting	SDS-5,5x210/150-Booster SDS-8x310/250-Booster	1	1605691 1605710
Brick drill - SDS fitting	SDS-8x260/200-Wallster	1	1605709

SFS-stock | EE-11313 Tallinn | Töökoja 1 | www.iDesigner.biz | F +372 6610 606

SFS-EE | ee.info@sfsintec.biz | www.sfsintec.biz/ee | T +372 6610 600

SFS-LT | lt.info@sfsintec.biz | www.sfsintec.biz/lt | T +370 699 24425