

aluminium support system for
rain screen cladding panels

NVELOPE SYSTEM NV10

CONTENTS:

NV10-01	Tolerances for adjustment
NV10-02	Elevation of cladding – details
NV10-03	Elevation of cladding
NV10-04	Horizontal section – NVELOPE 90
NV10-05	Vertical section – NVELOPE 90 SINGLE
NV10-06	Vertical section – NVELOPE 90 DOUBLE
NV10-07	Vertical section with joint in profile
NV10-08	Vertical section – base detail
NV10-09	Vertical section – head of cladding
NV10-10	Horizontal section–external corner
NV10-11	Horizontal section–internal corner
NV10-12	Horizontal section–window jamb detail
NV10-13	Vertical section–window sill detail
NV10-14	Vertical section–window head detail
NV10-15	Vertical section–keil anchor secret fix
NV10-16	Horizontal section–keil anchor secret fix
NV10-17	Final fix detail
NV10-18	Clips and rail dimsl

LEGEND:

A	– Cladding
B	– SR2 4.8 x 19 self drilling stainless steel screw
C1	– Secret fixing clip with levelling screw
C2	– Secret fixing clip.
D	– Screw
E	– Fixing screw
F	– Window profile
G	– Sika Tape
H	– Sika Adhesive

1	– Steel frame wall
2	– NVELOPE – support bracket
3	– Primary Fixing
4	– L profile vertical (60 X 40 X 2.2)
5	– SR2 self drilling stainless steel screw
6	– Horizontal Profile
7	– Insulation
8	– Ventilation
10	– NVELOPE Isolator
11	– NV10 Rail
12	– Keil Anchor

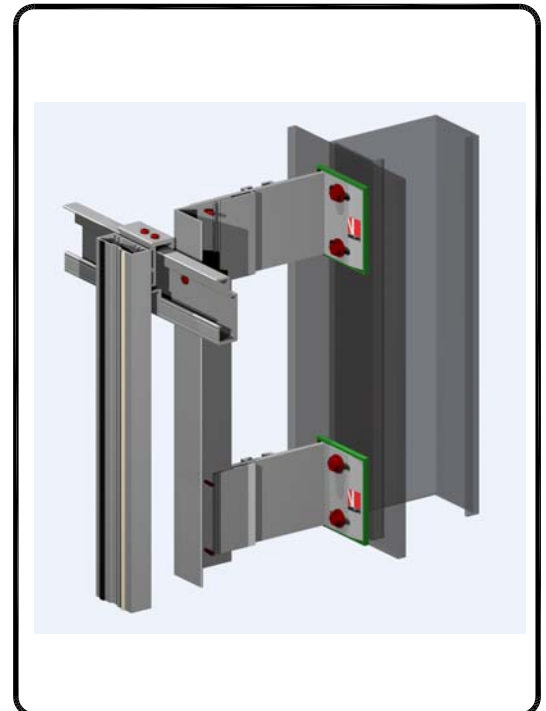
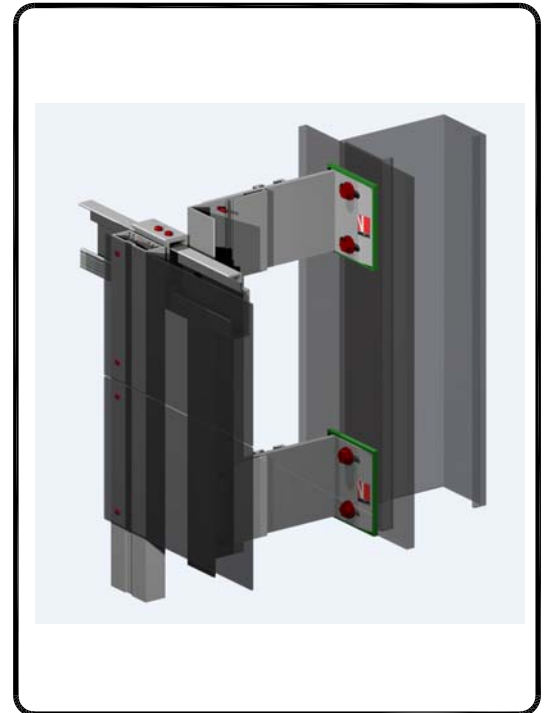

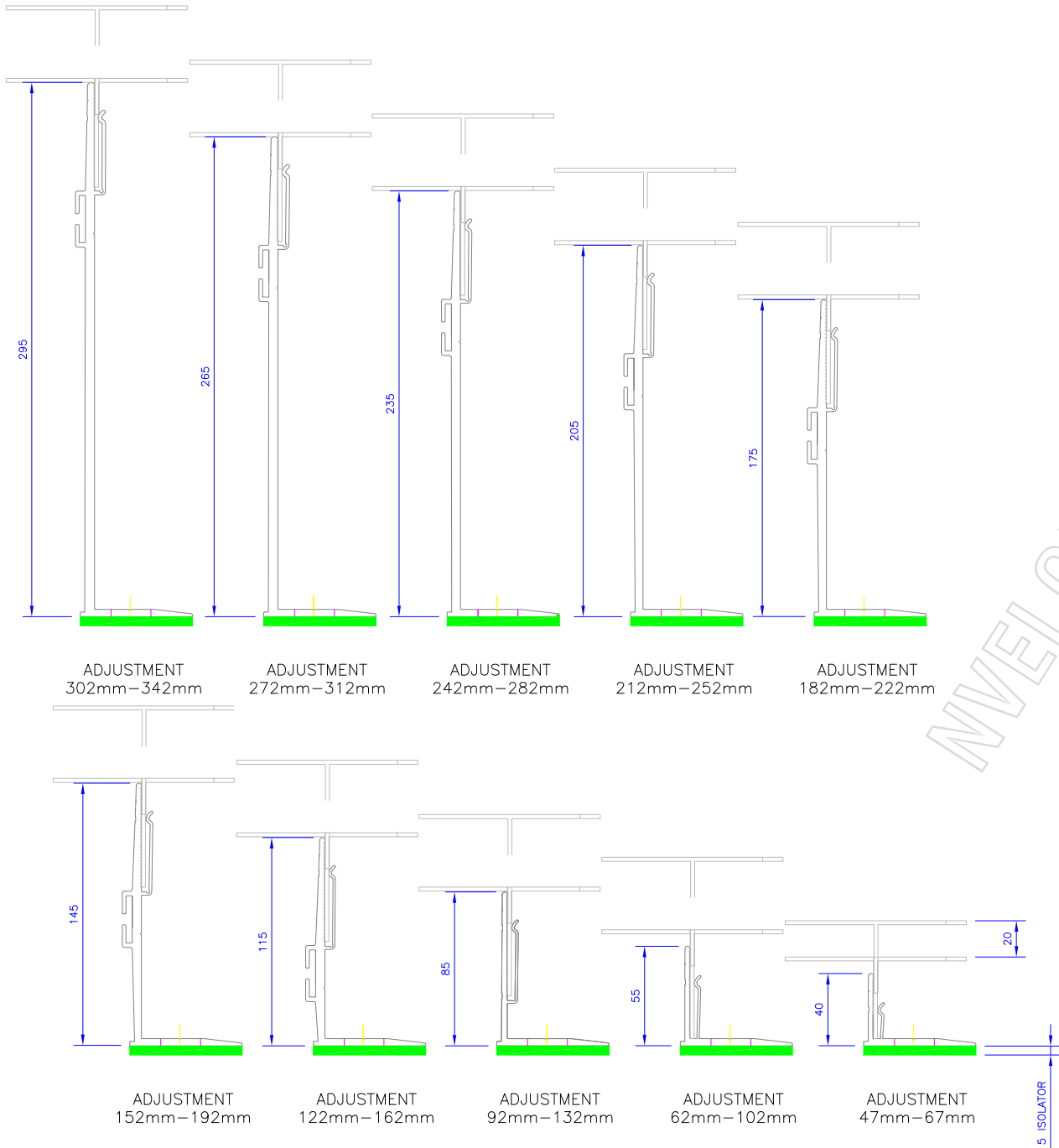

BRACKETS	Adjustment range for each bracket (mm)	
Nvelope 40	from 47	to 67
Nvelope 60	from 62	to 102
Nvelope 90	from 92	to 132
Nvelope 120	from 122	to 162
Nvelope 150	from 152	to 192
Nvelope 180	from 182	to 222
Nvelope 210	from 212	to 252
Nvelope 240	from 242	to 282
Nvelope 270	from 272	to 312
Nvelope 300	from 302	to 342

HORIZONTAL SECTIONS
TOLERANCES FOR ADJUSTMENT

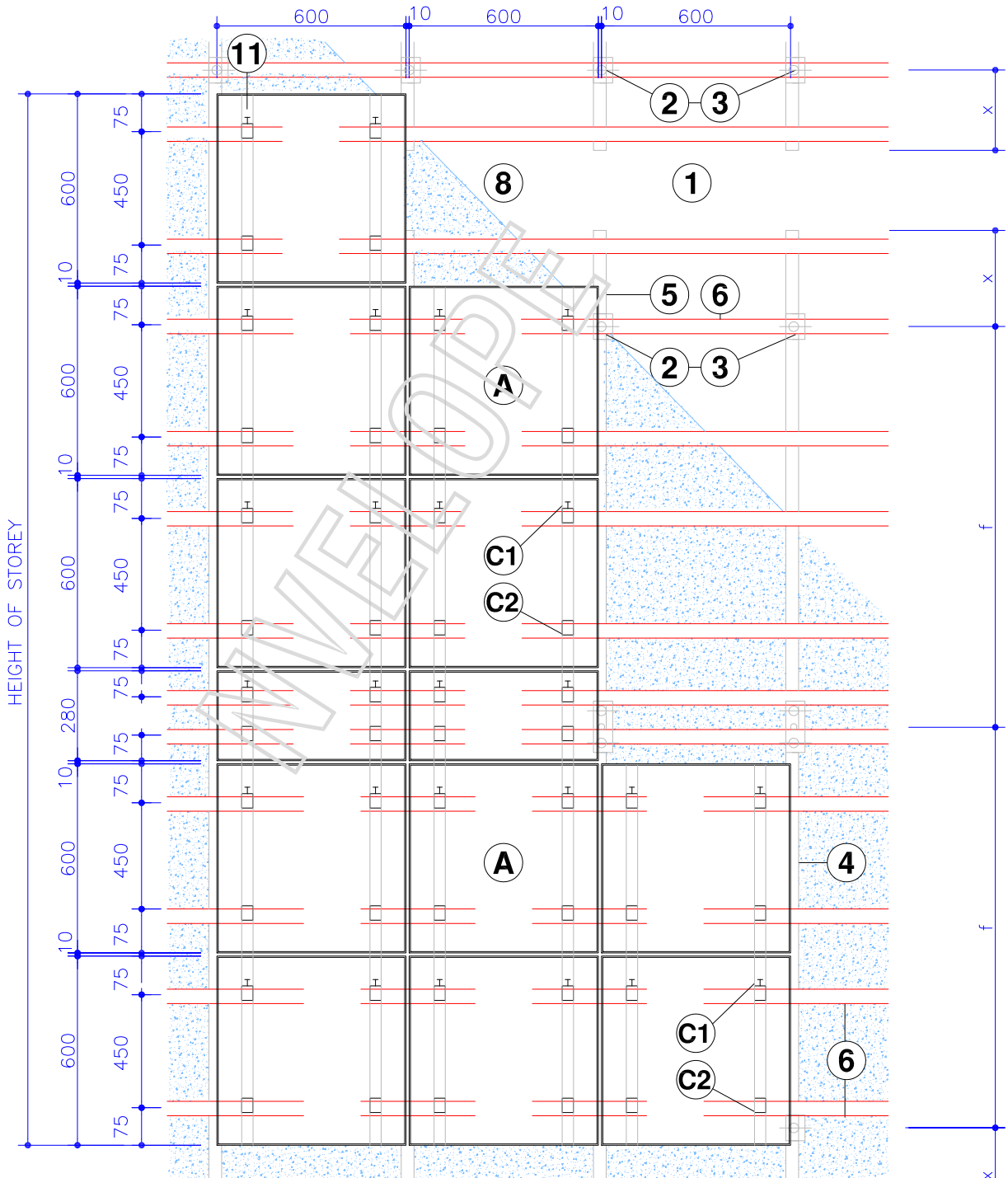

PANEL MODULE 60 x 60 or 60 x 30
 ELEVATION OF CLADDING

REFER TO DRAWING
NV10-16

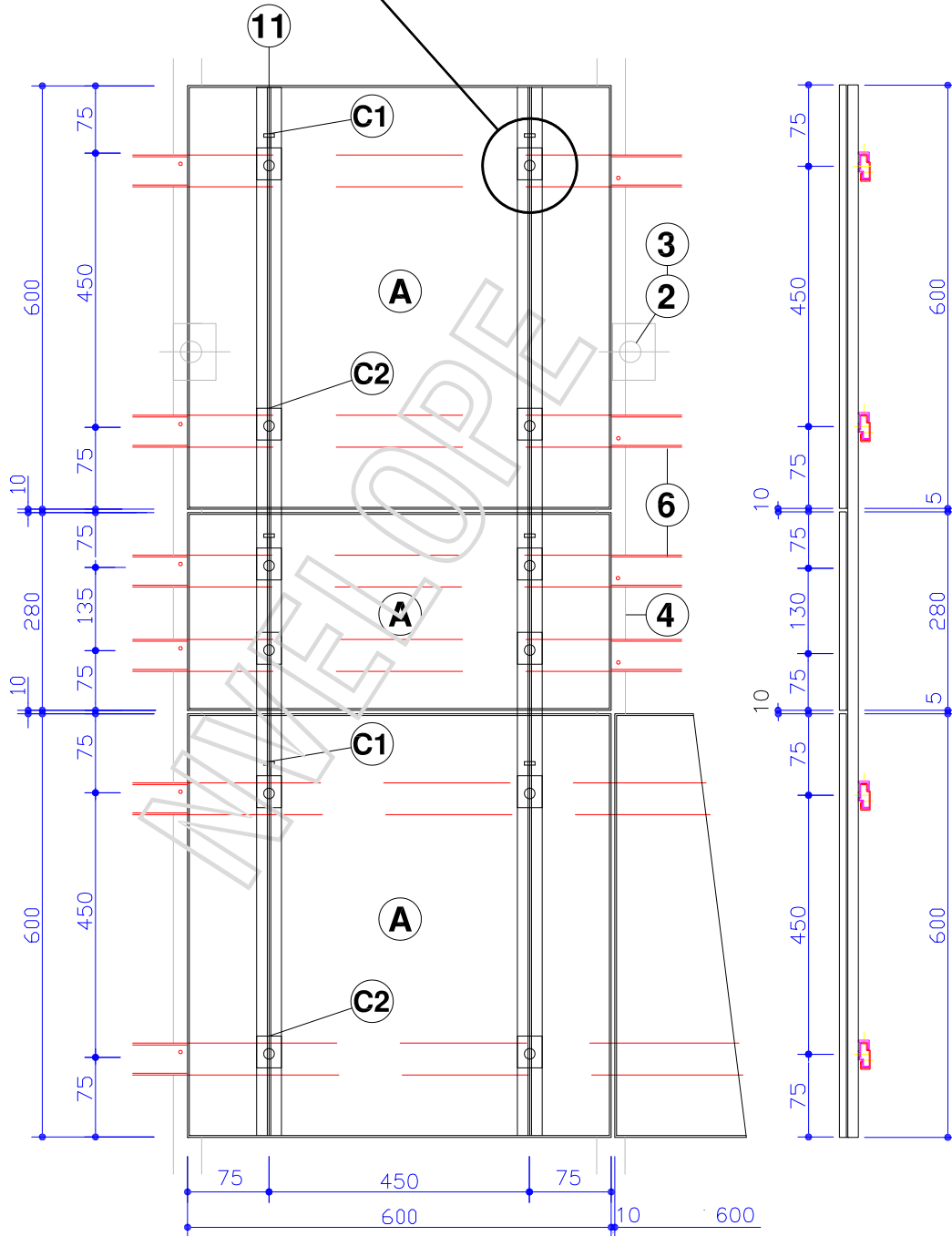

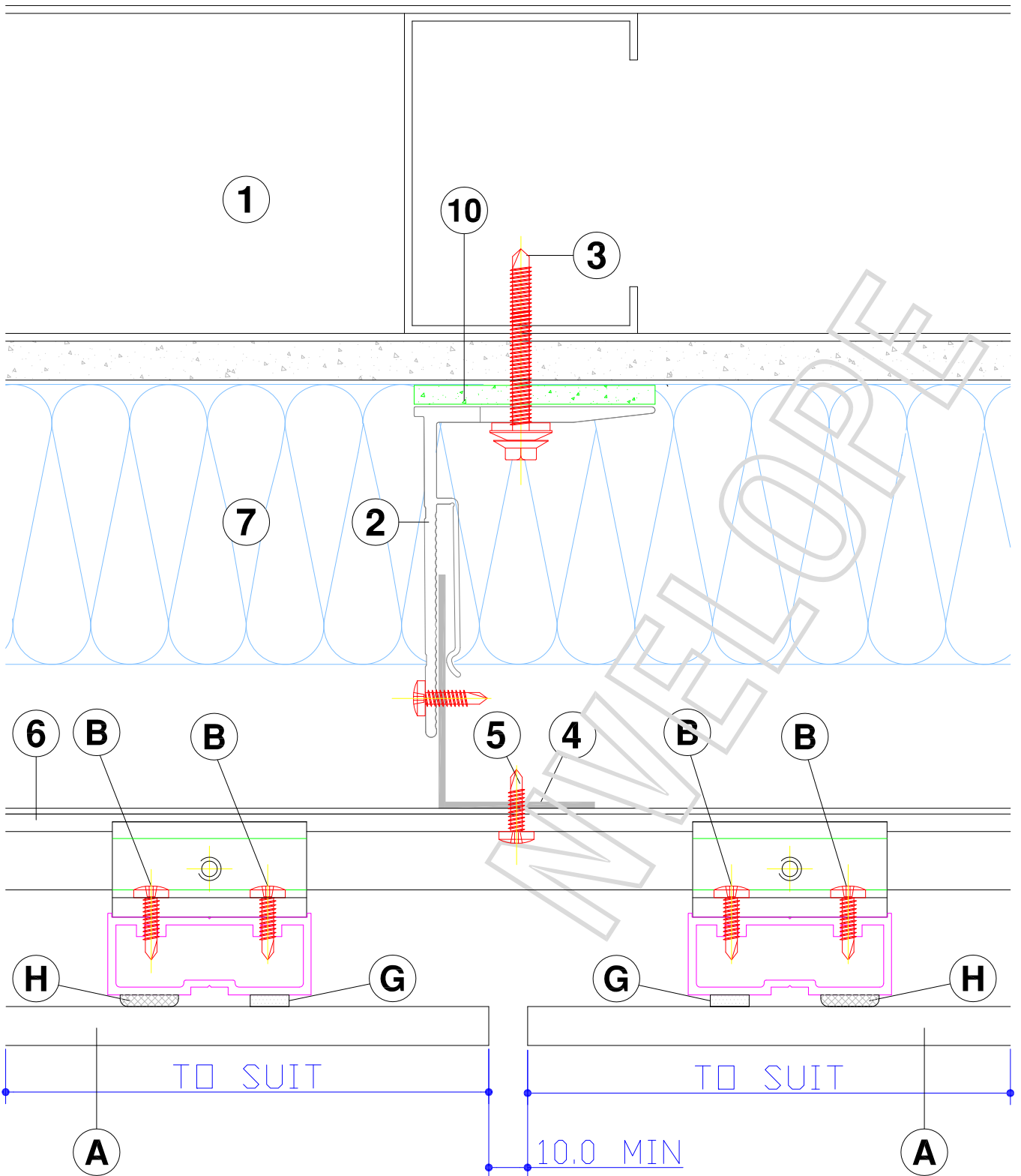

HORIZONTAL SECTION - NVELOPE 90

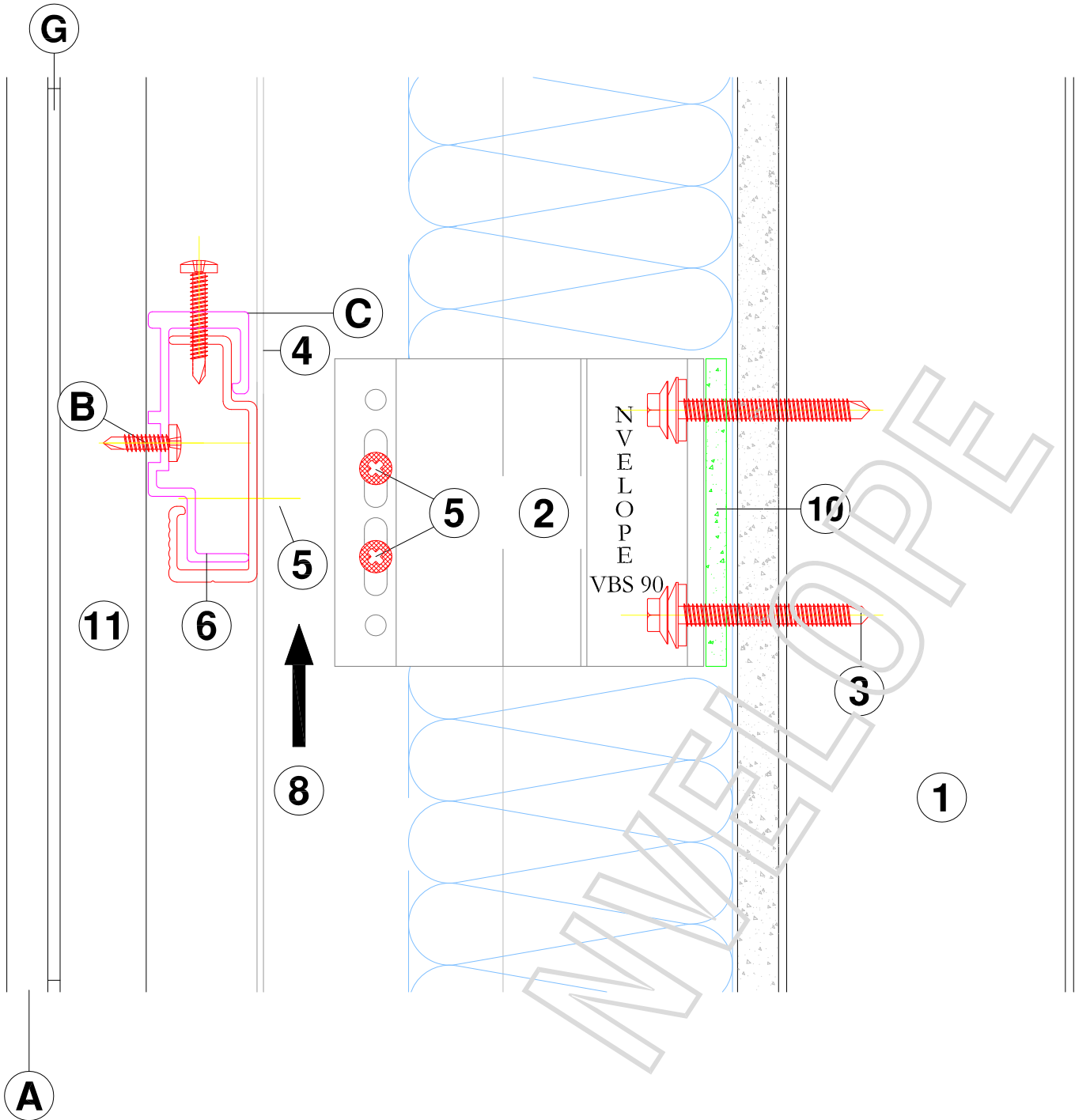

VERTICAL SECTION - NVELOPE 90 SINGLE

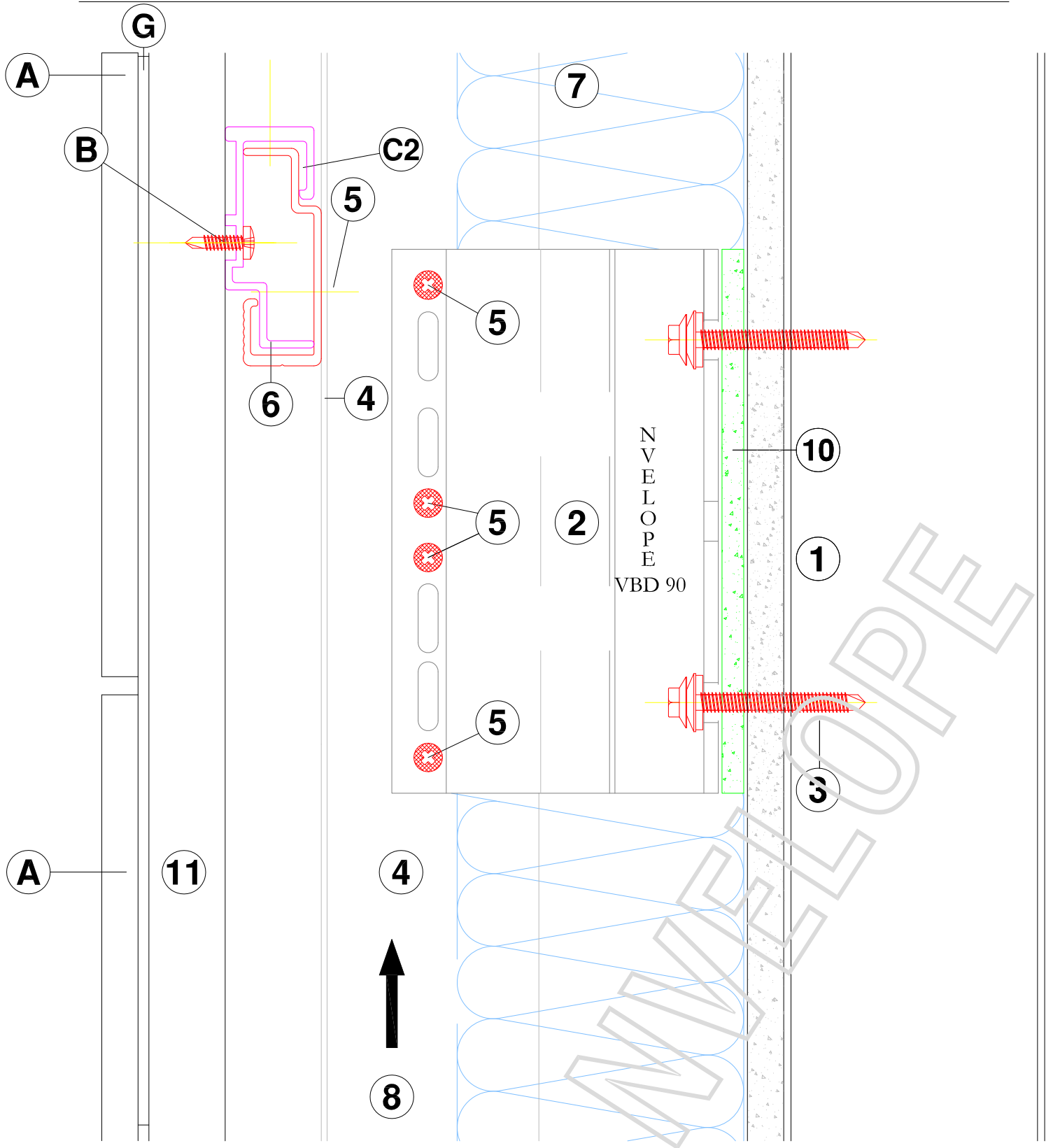

VERTICAL SECTION - NVELOPE DOUBLE

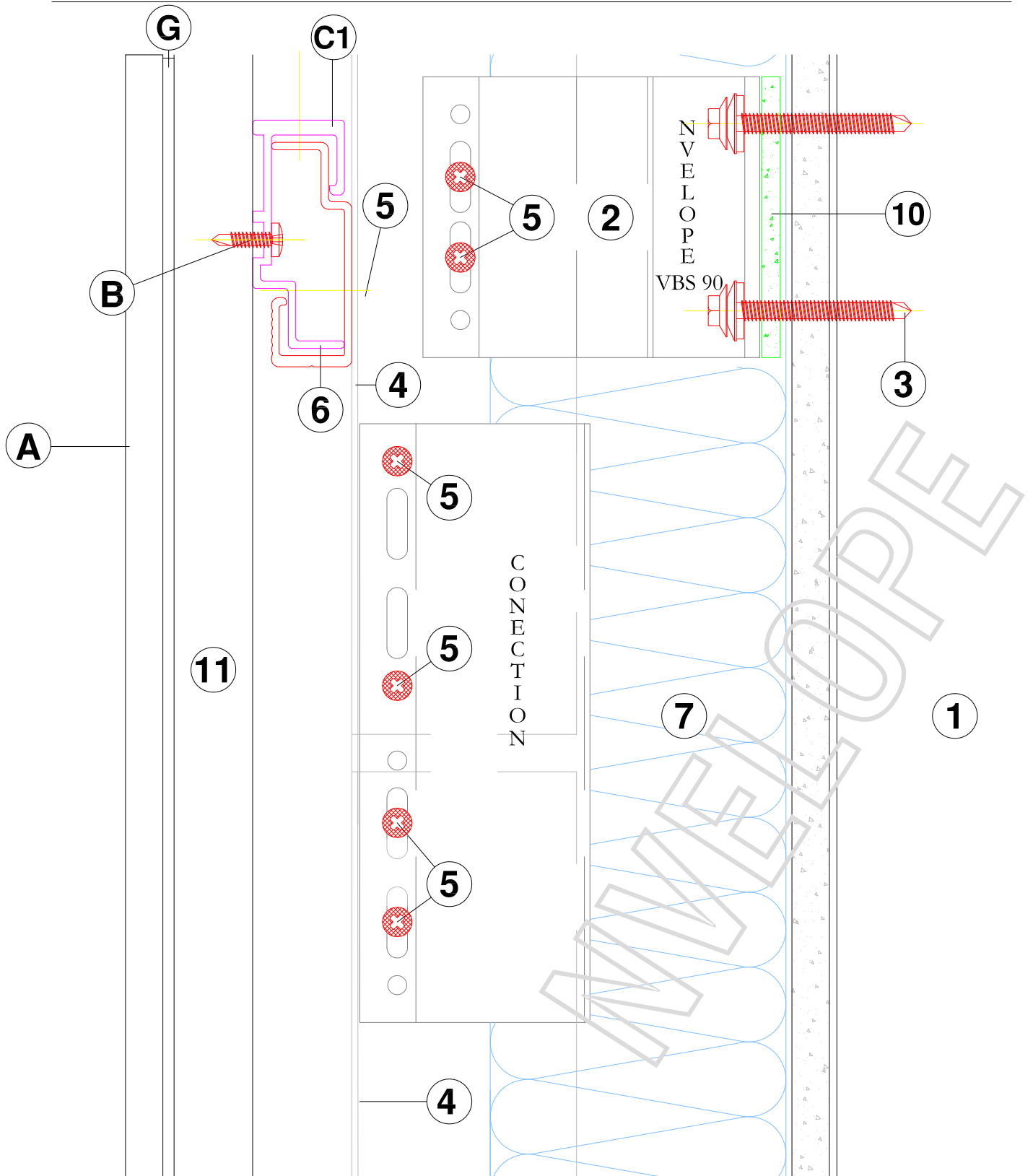

VERTICAL SECTION - CONNECTION PIECE - JOINING OF PROFILES

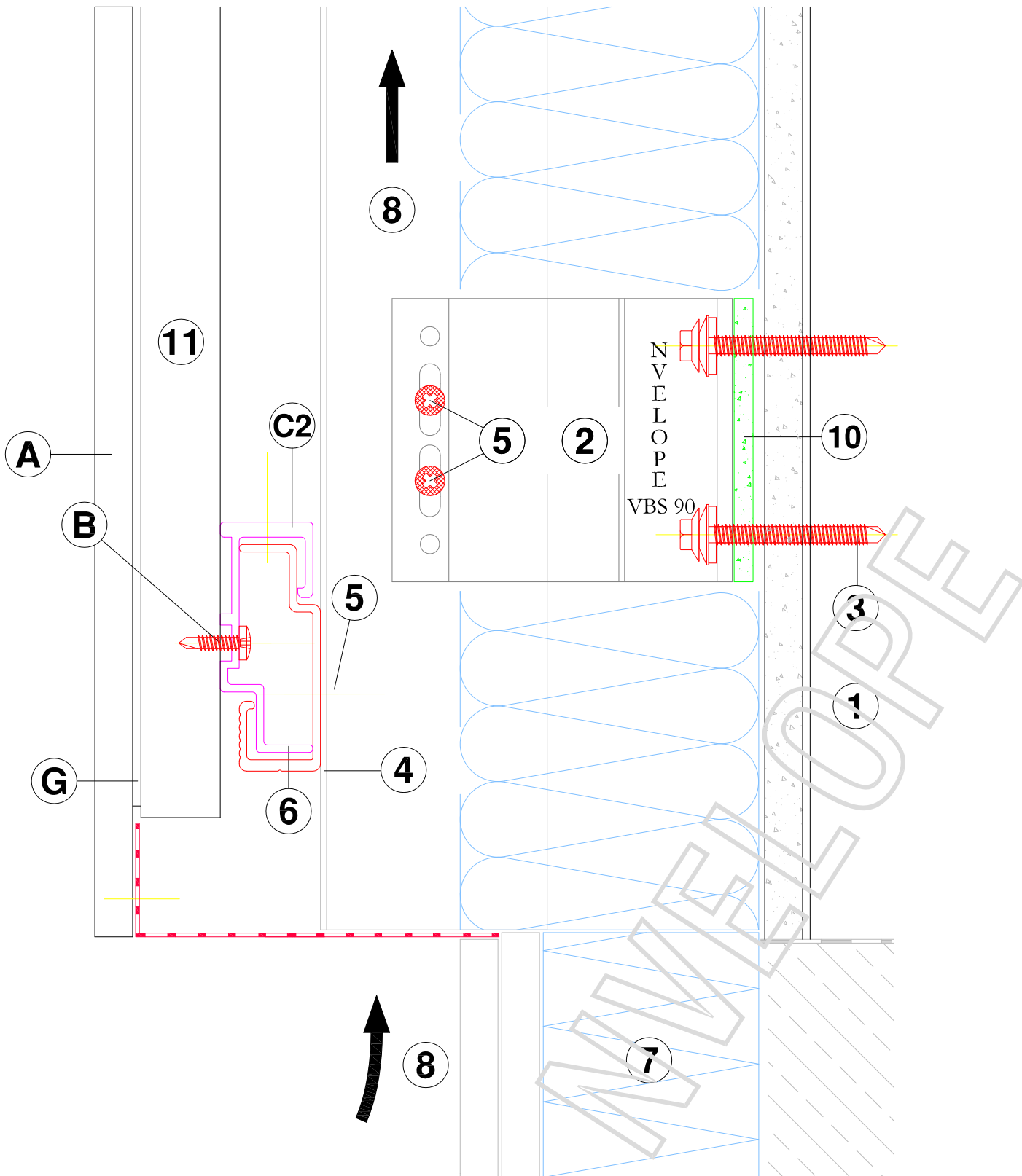

VERTICAL SECTION - BASE OF CLADDING

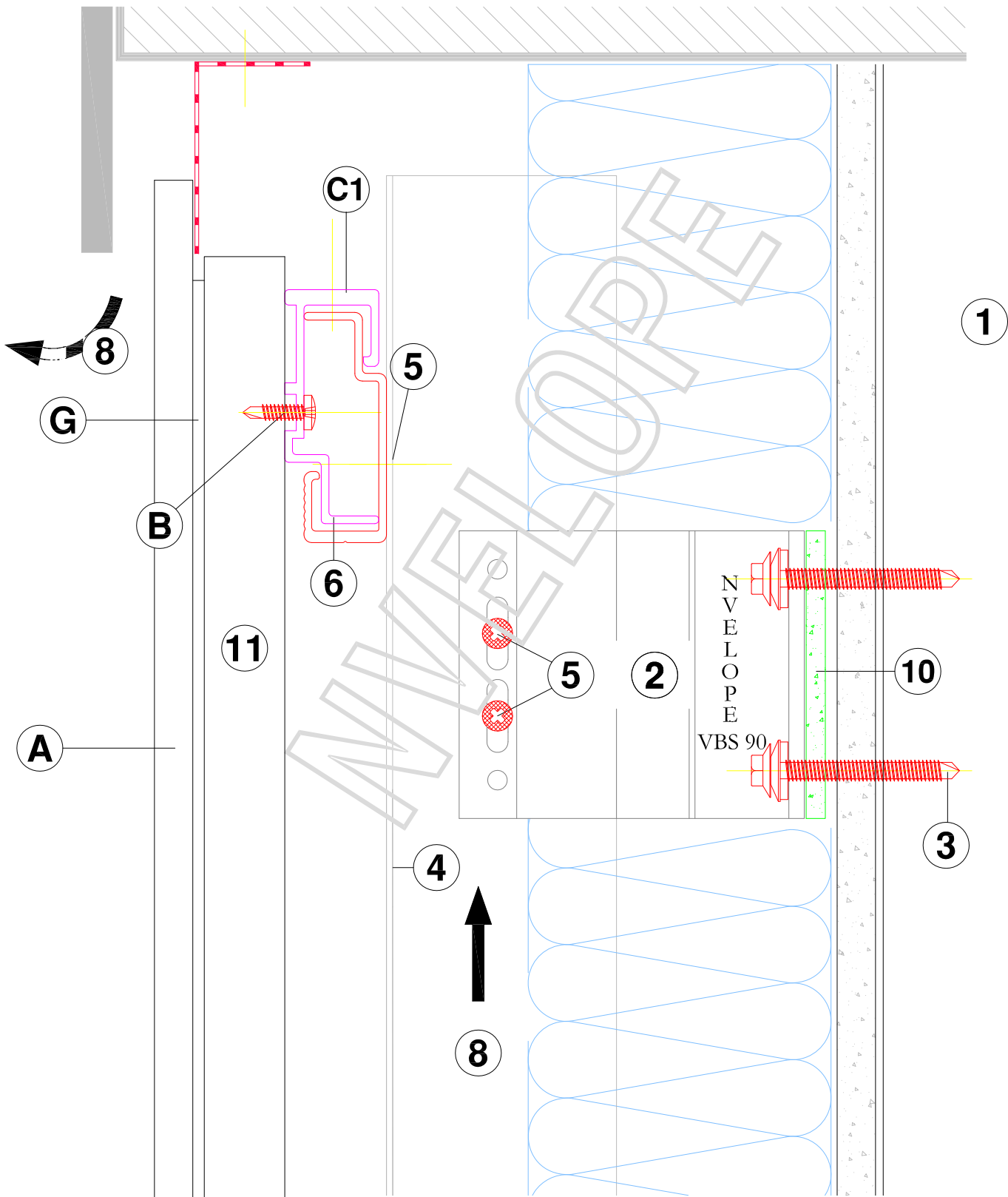

VERTICAL SECTION - HEAD OF CLADDING

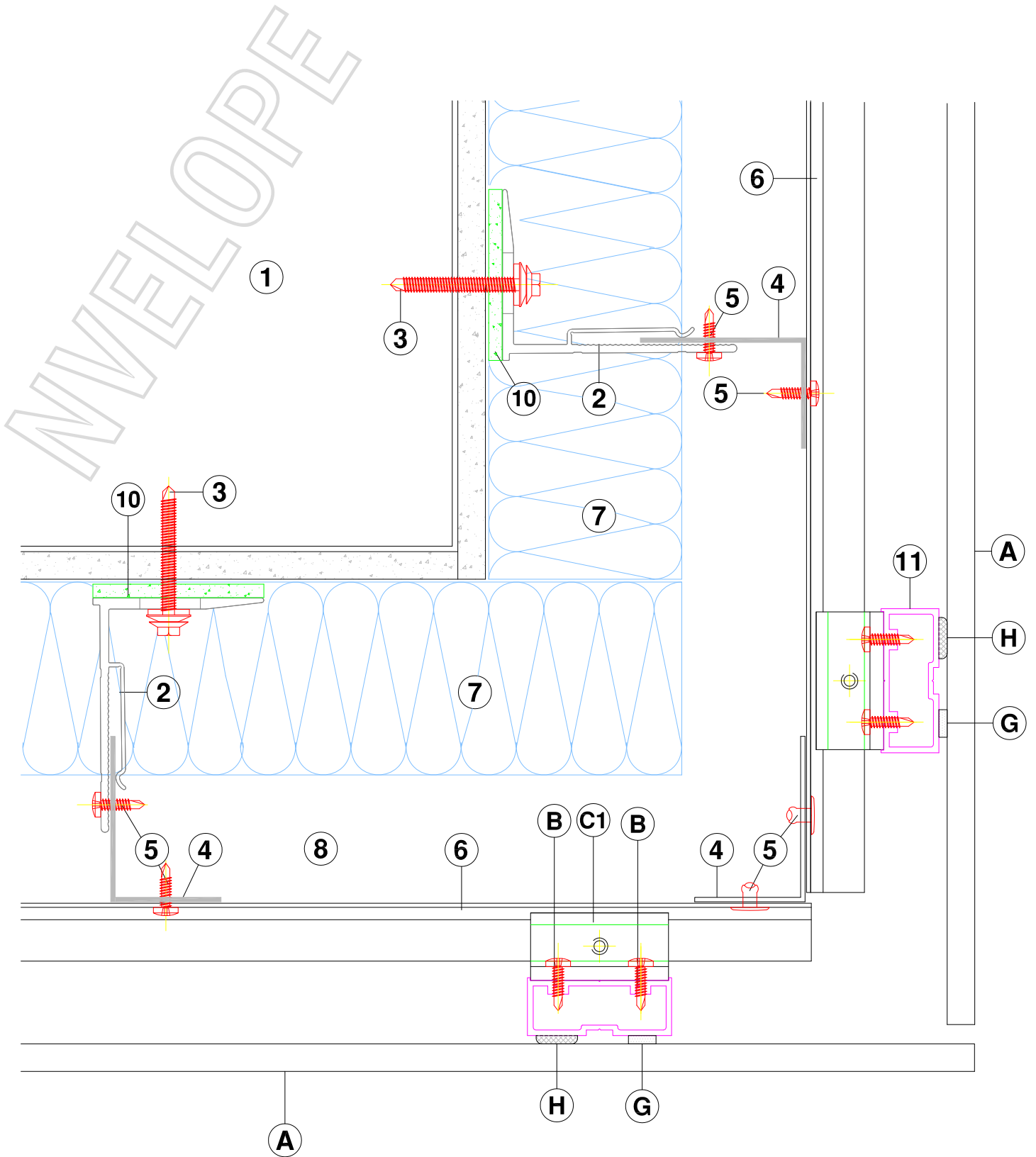

HORIZONTAL SECTION - EXTERNAL CORNER

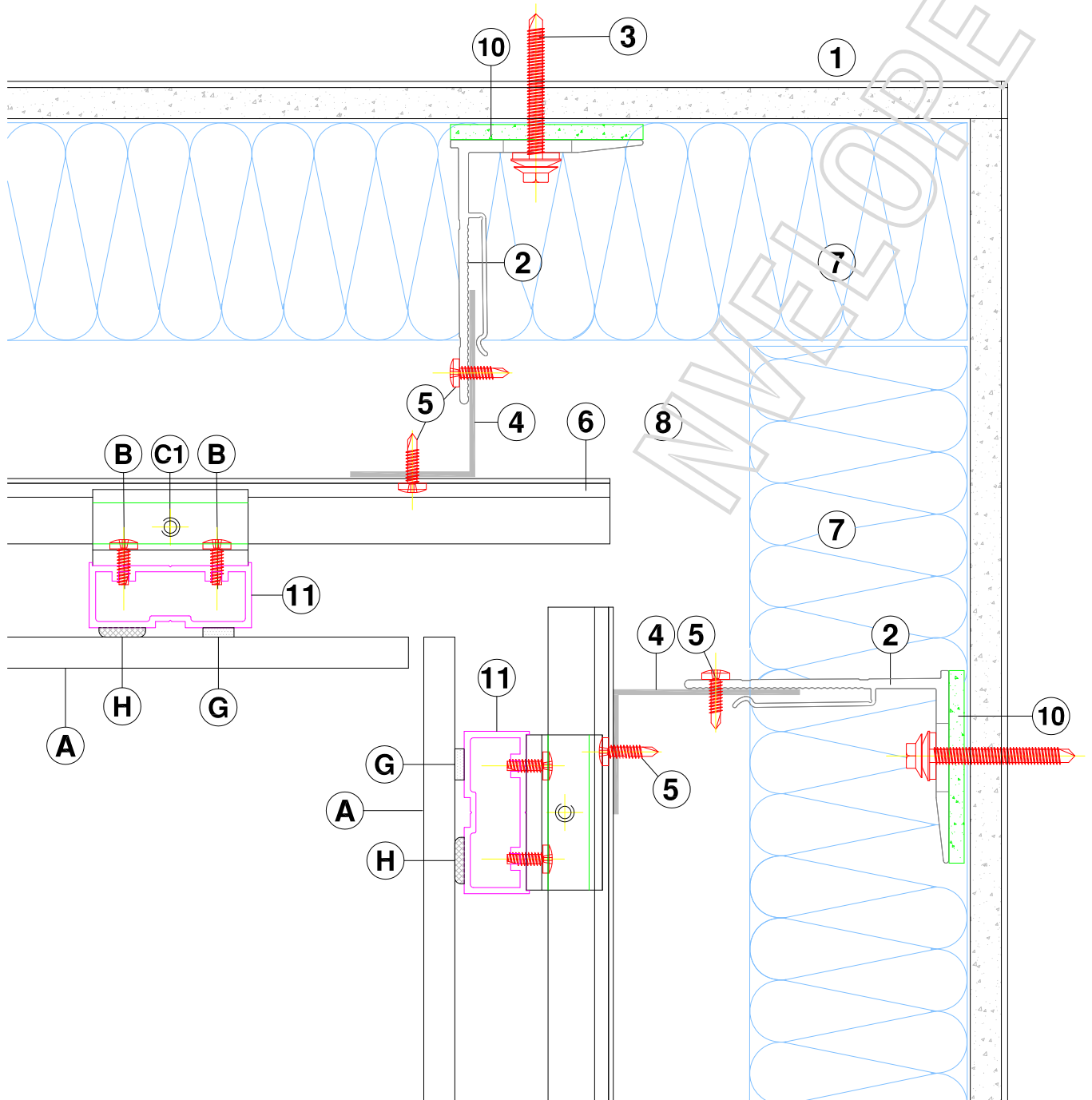

HORIZONTAL SECTION - INTERNAL CORNER

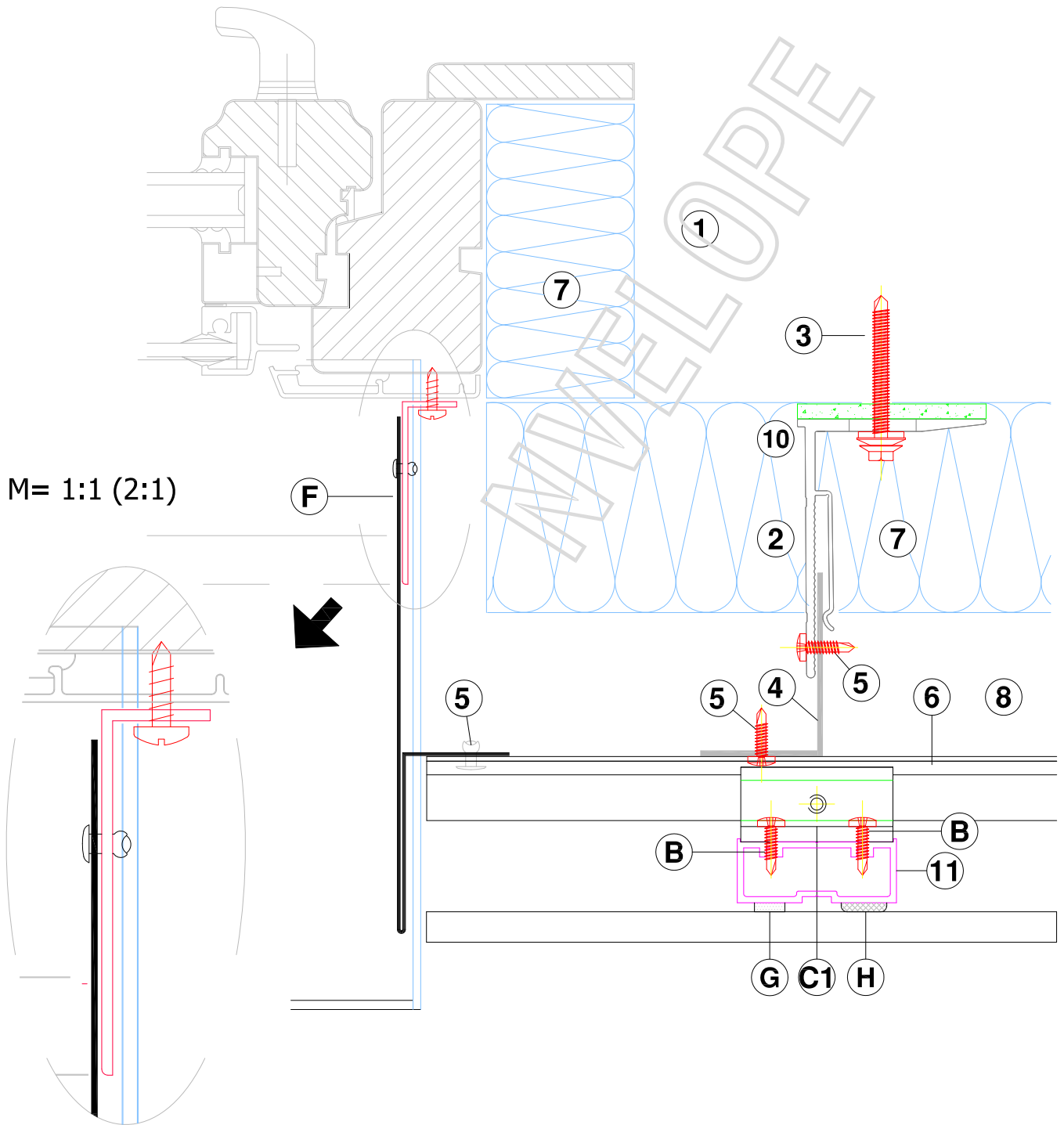

HORIZONTAL SECTION - WINDOW JAMB DETAIL

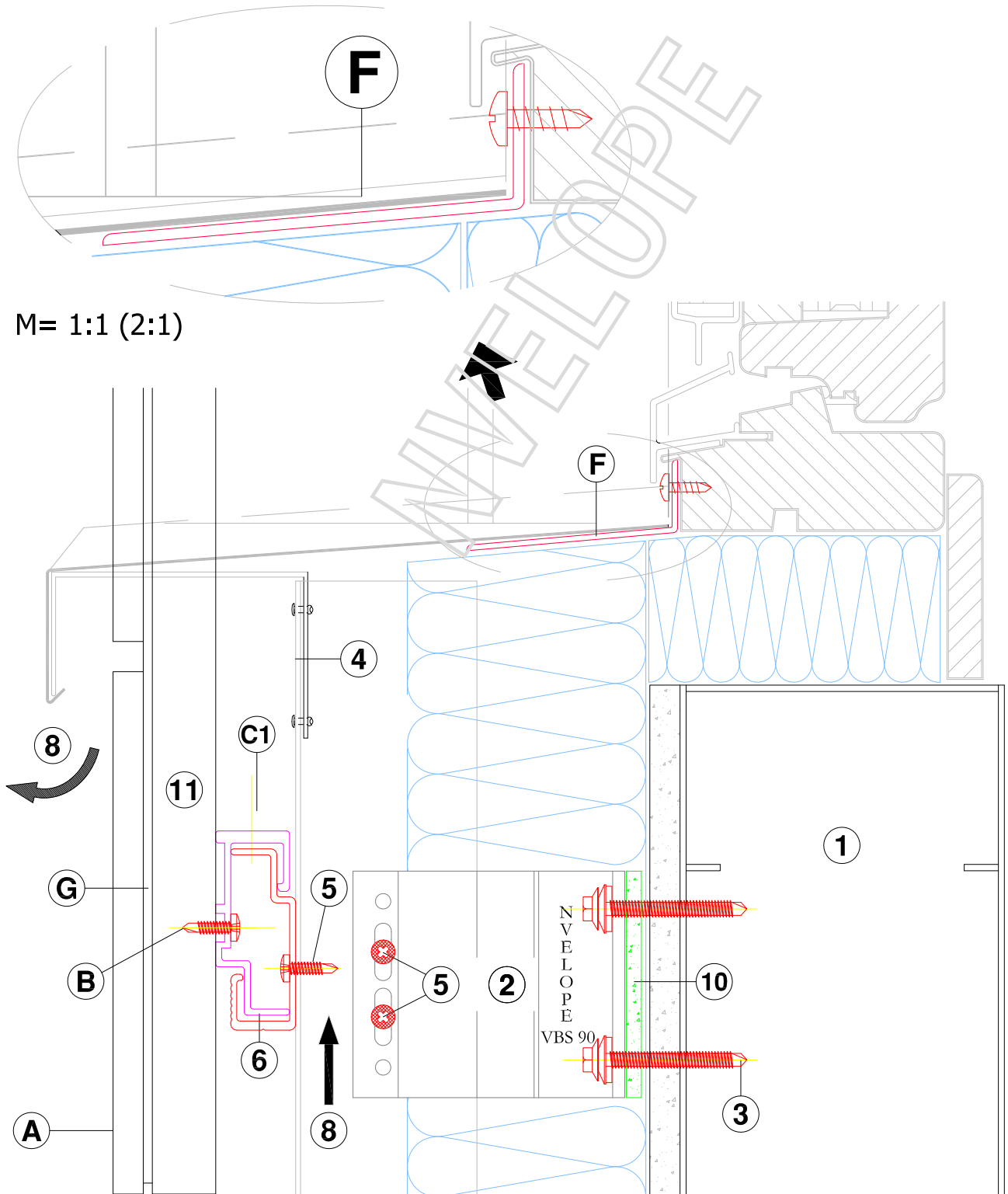

VERTICAL SECTION - WINDOW SILL DETAIL

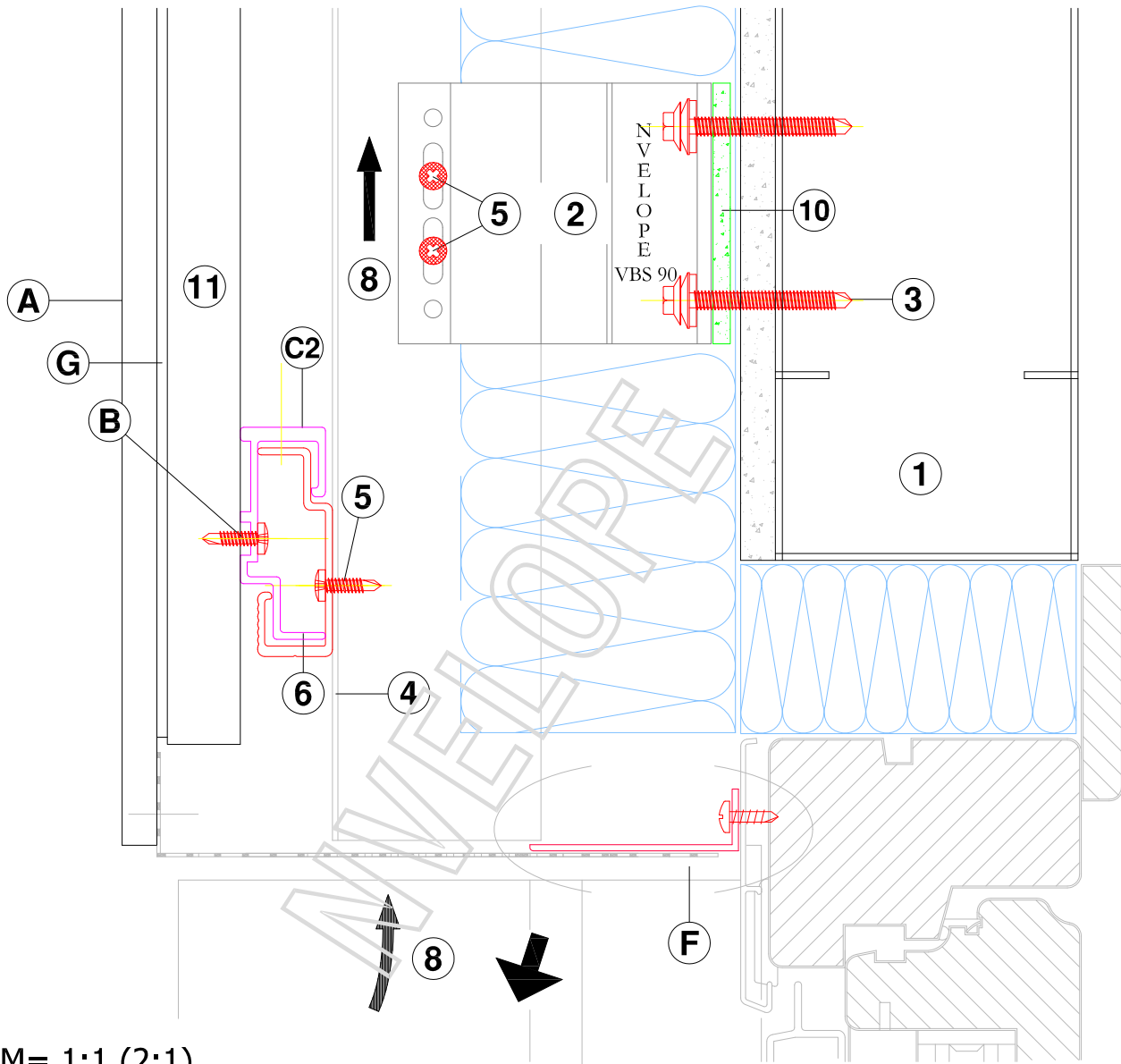

M= 1:1 (2:1)

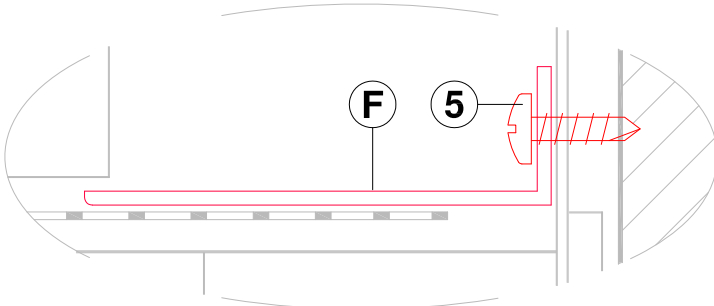

VERTICAL SECTION - WINDOW DETAIL HEAD

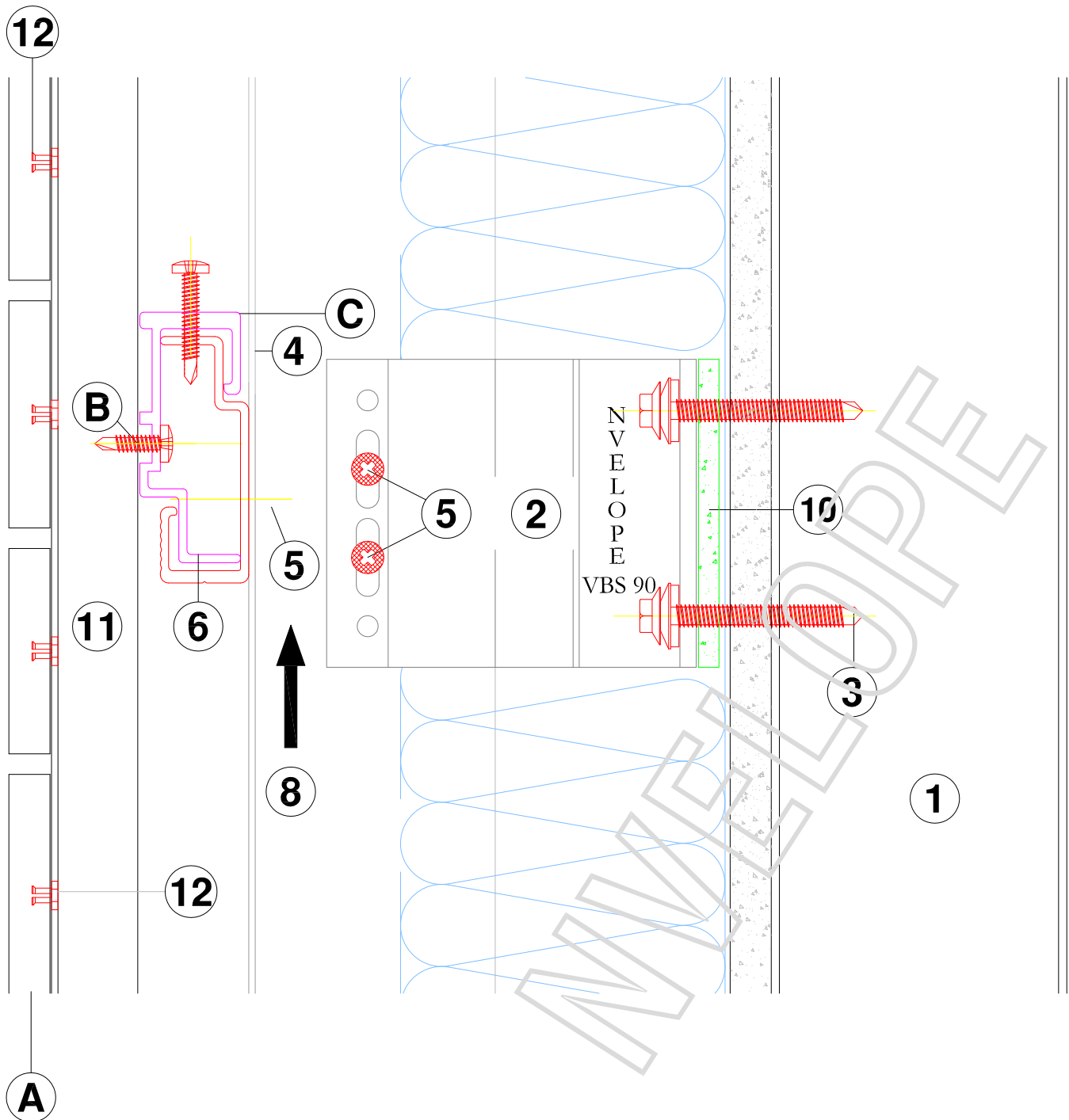

VERTICAL SECTION - KEIL ANCHOR SECRET FIX

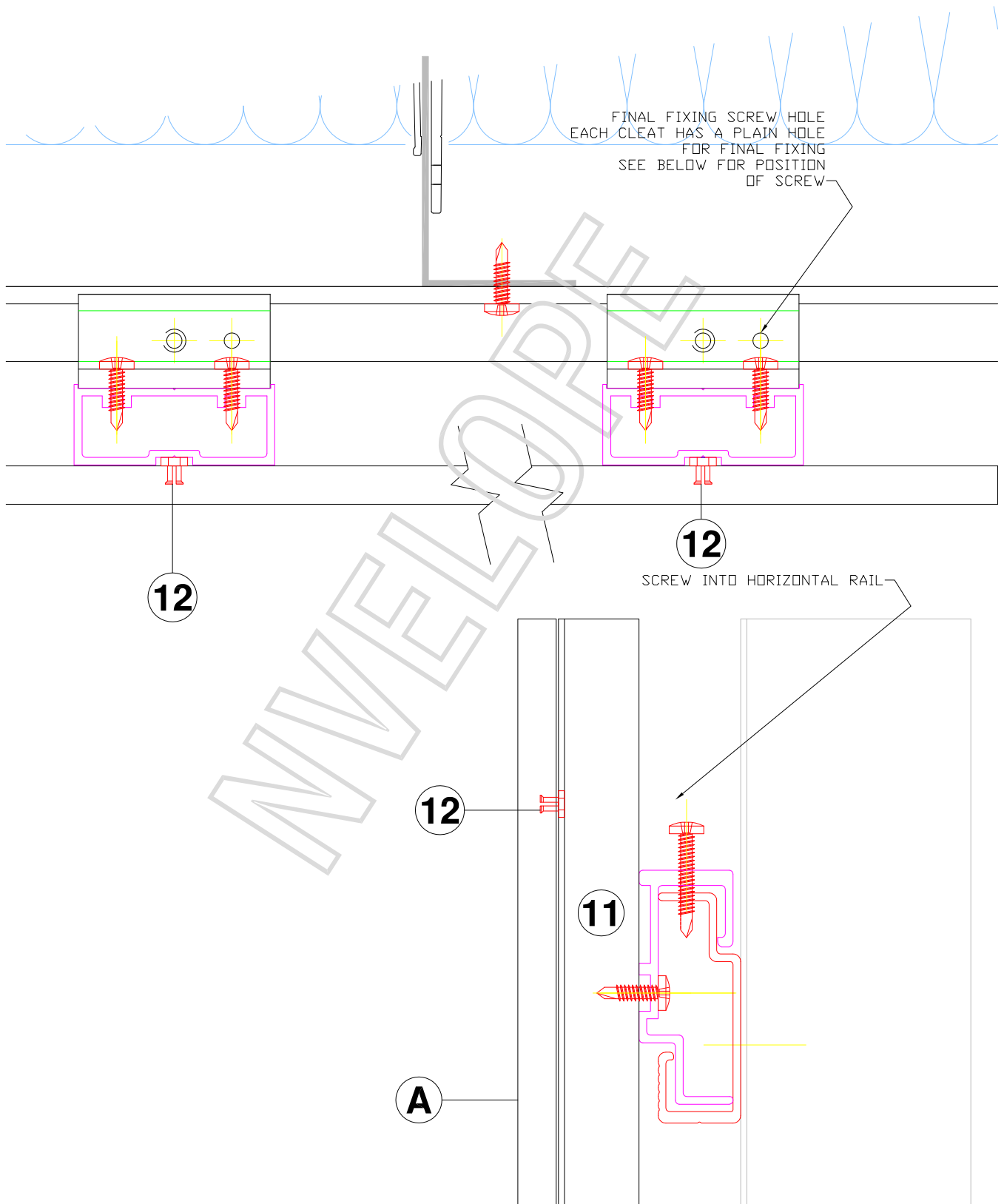

HORIZONTAL SECTION - KEIL ANCHOR SECRET FIX

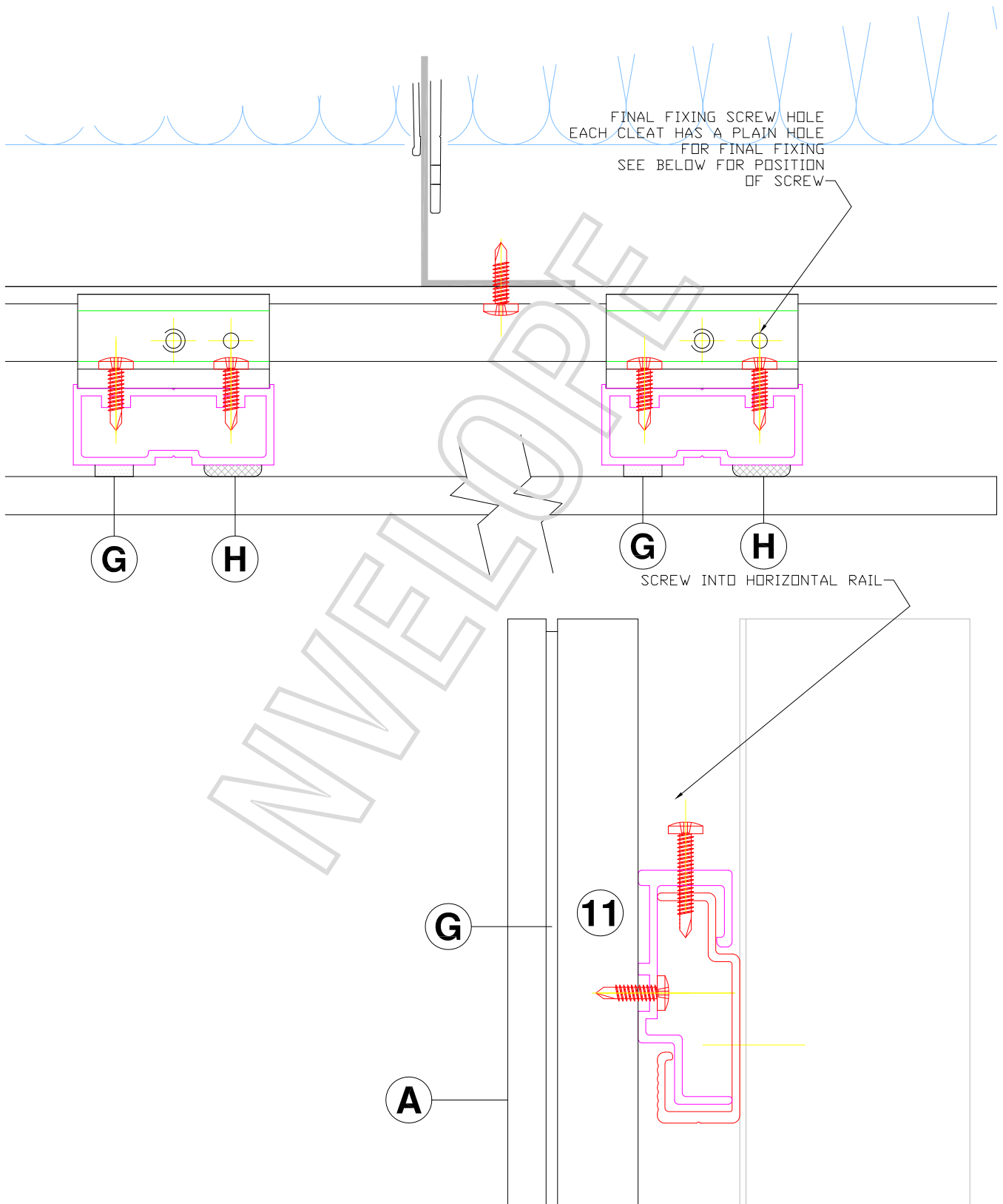

FINAL FIXING SCREW

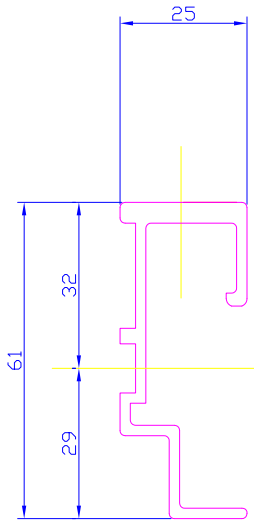

NV3 HANGER

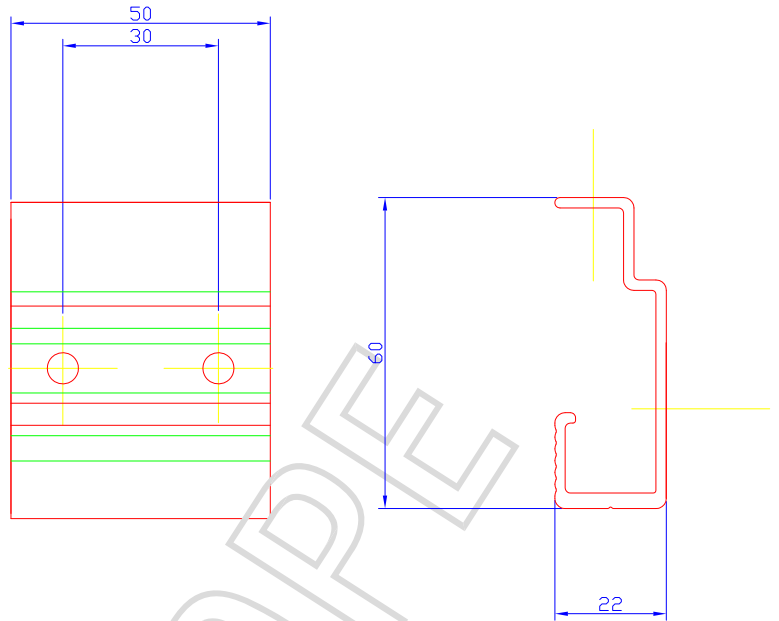

NV3 RAILS

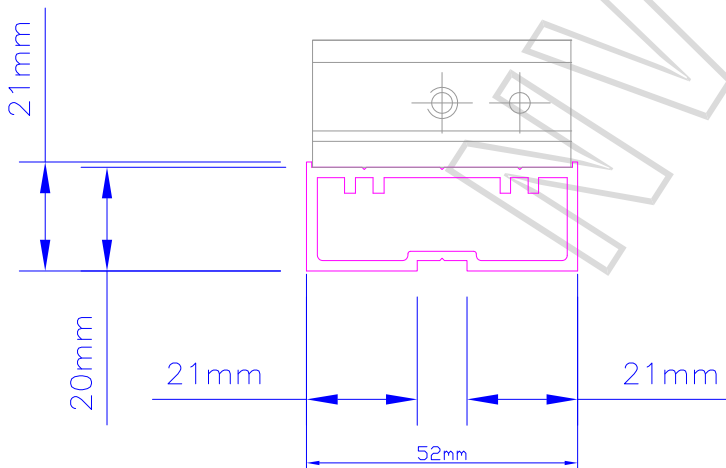

NV10 RAIL

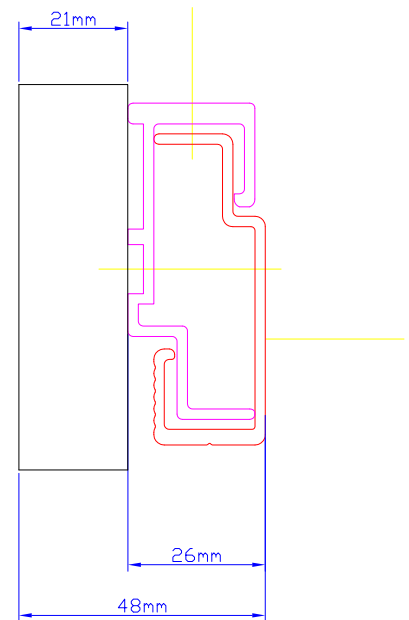

ASSEMBLY DIM