

aluminium support system for  
rainscreen cladding

## NVELOPE NV2 SYSTEM STRUCTURAL BONDING ( FEATURING SIKA TACK PANEL SYSTEM )

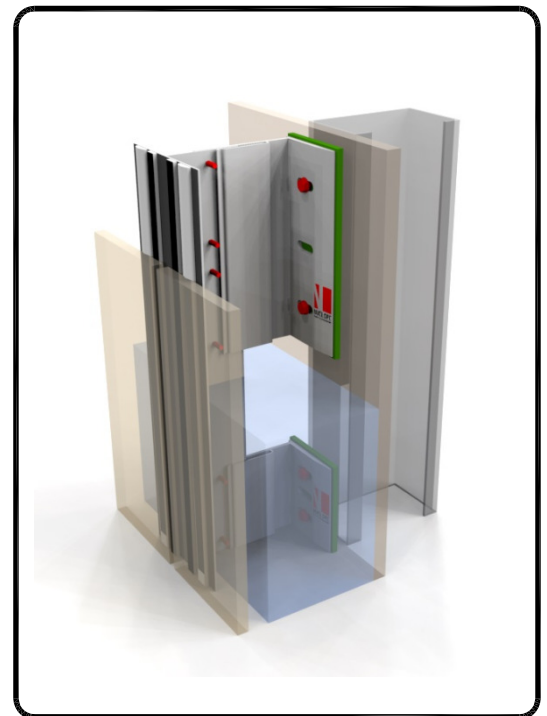

### LEGEND:

- A - Cladding
- B - Sika Tape
- C - Sika Adhesive
- 1 - SFS steel wall + cement board
- 2 - NVELOPE - support bracket
- 3 - Stainless steel fixing
- 4 - T-(L) profile vertical
- 5 - Self drilling stainless steel screw SR2 4.2 x 16
- 7 - Thermal insulation
- 8 - Ventilation
- 10 - NVELOPE thermal isolator
- 11 - Corner Bracket
- 12 - Corner Rail

### CONTENTS:

- NV2-00 System detail sheet
- NV2-01 Tolerances for bracket adjustment
- NV2-02 Cladding view locations
- NV2-03 Horizontal section
- NV2-04a Typical section double bracket
- NV2-04b Typical section single bracket and profile connection
- NV2-05 Vertical section-base of cladding
- NV2-06 Vertical section-top of cladding
- NV2-07 Horizontal section window jamb
- NV2-08 Vertical section window sill
- NV2-09 Vertical section window head
- NV2-10a External corner
- NV2-10b External corner with corner bracket
- NV2-11 Internal corner
- NV2-12 SIK A Adhesive use

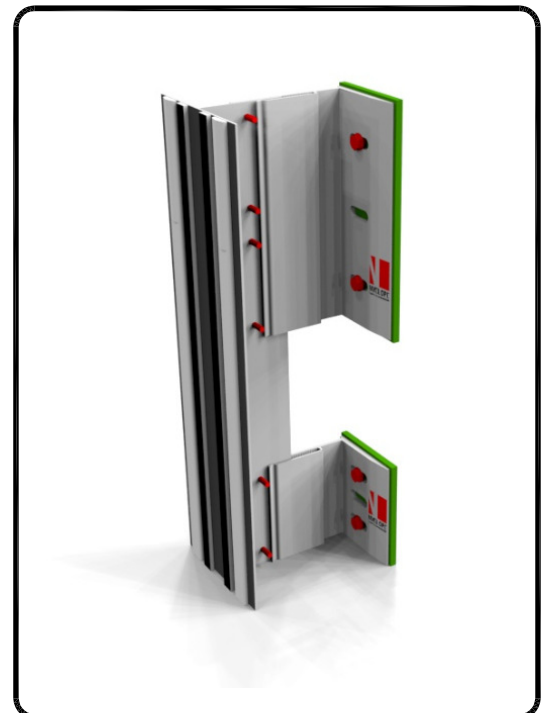

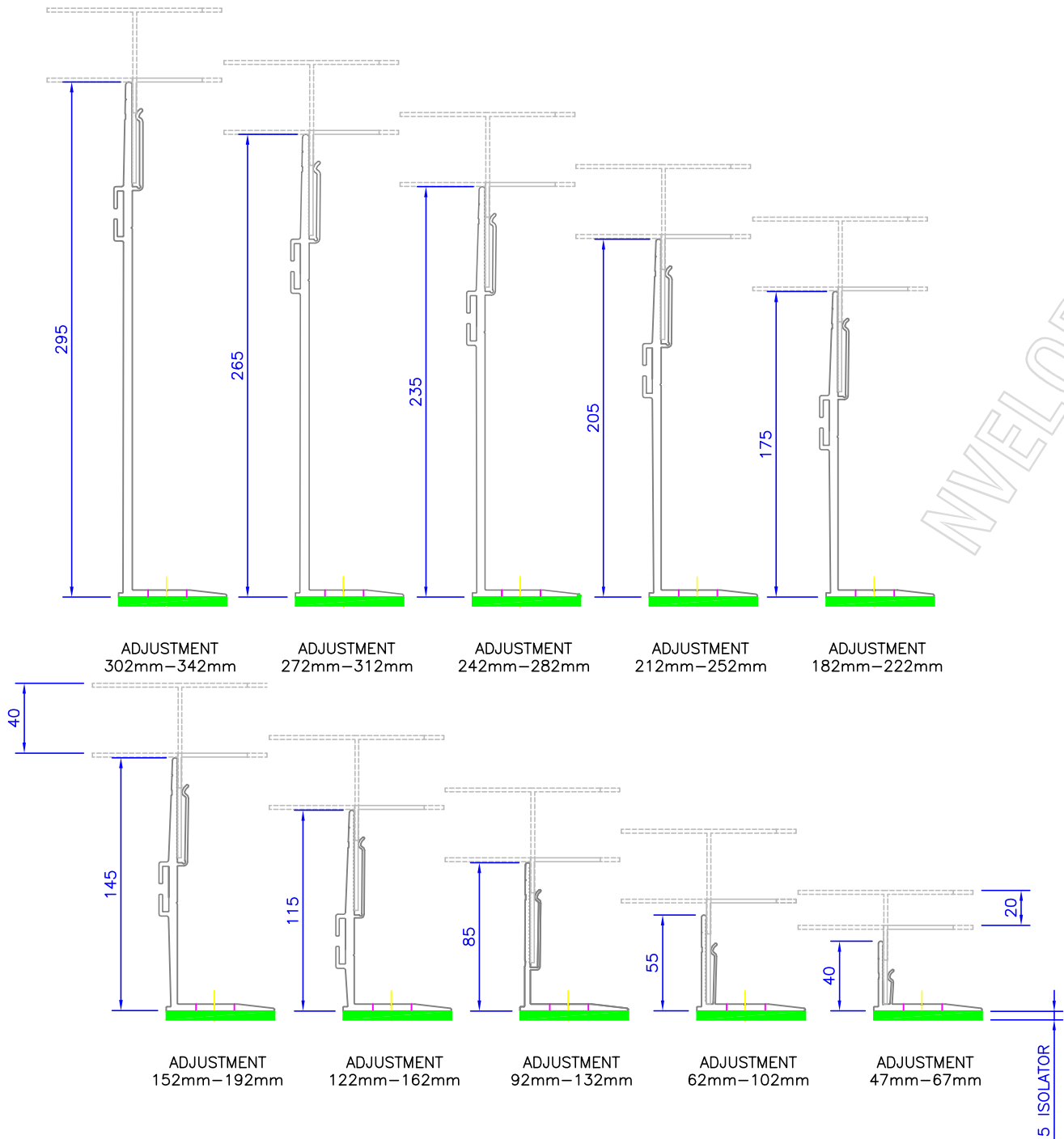

BRACKETS	Adjustment range for each bracket ( mm )	
Nvelope 40	from 47	to 67
Nvelope 60	from 62	to 102
Nvelope 90	from 92	to 132
Nvelope 120	from 122	to 162
Nvelope 150	from 152	to 192
Nvelope 180	from 182	to 222
Nvelope 210	from 212	to 252
Nvelope 240	from 242	to 282
Nvelope 270	from 272	to 312
Nvelope 300	from 302	to 342

HORIZONTAL SECTIONS  
TOLERANCES FOR ADJUSTMENT

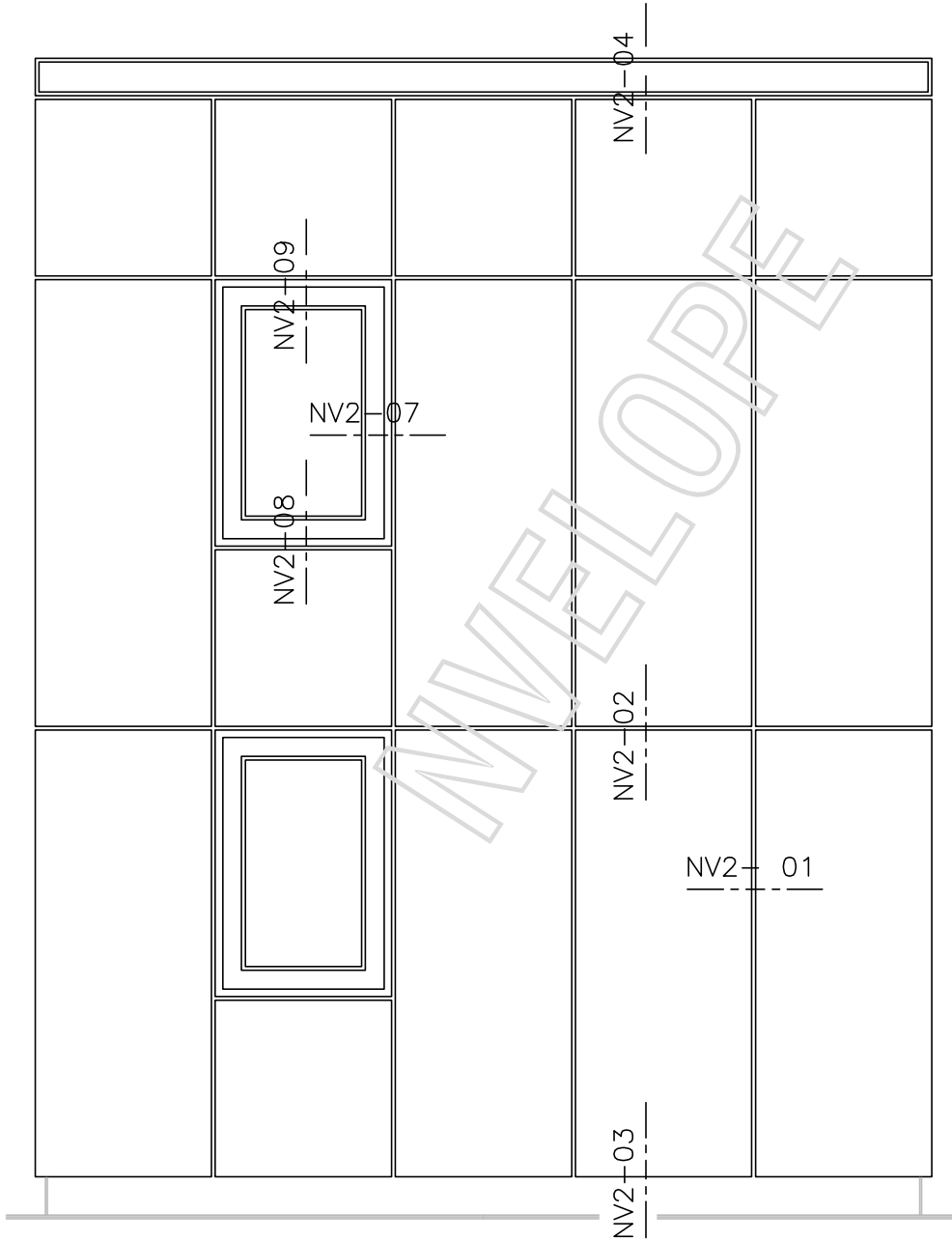

VIEW OF CLADDING - DETAIL LOCATIONS

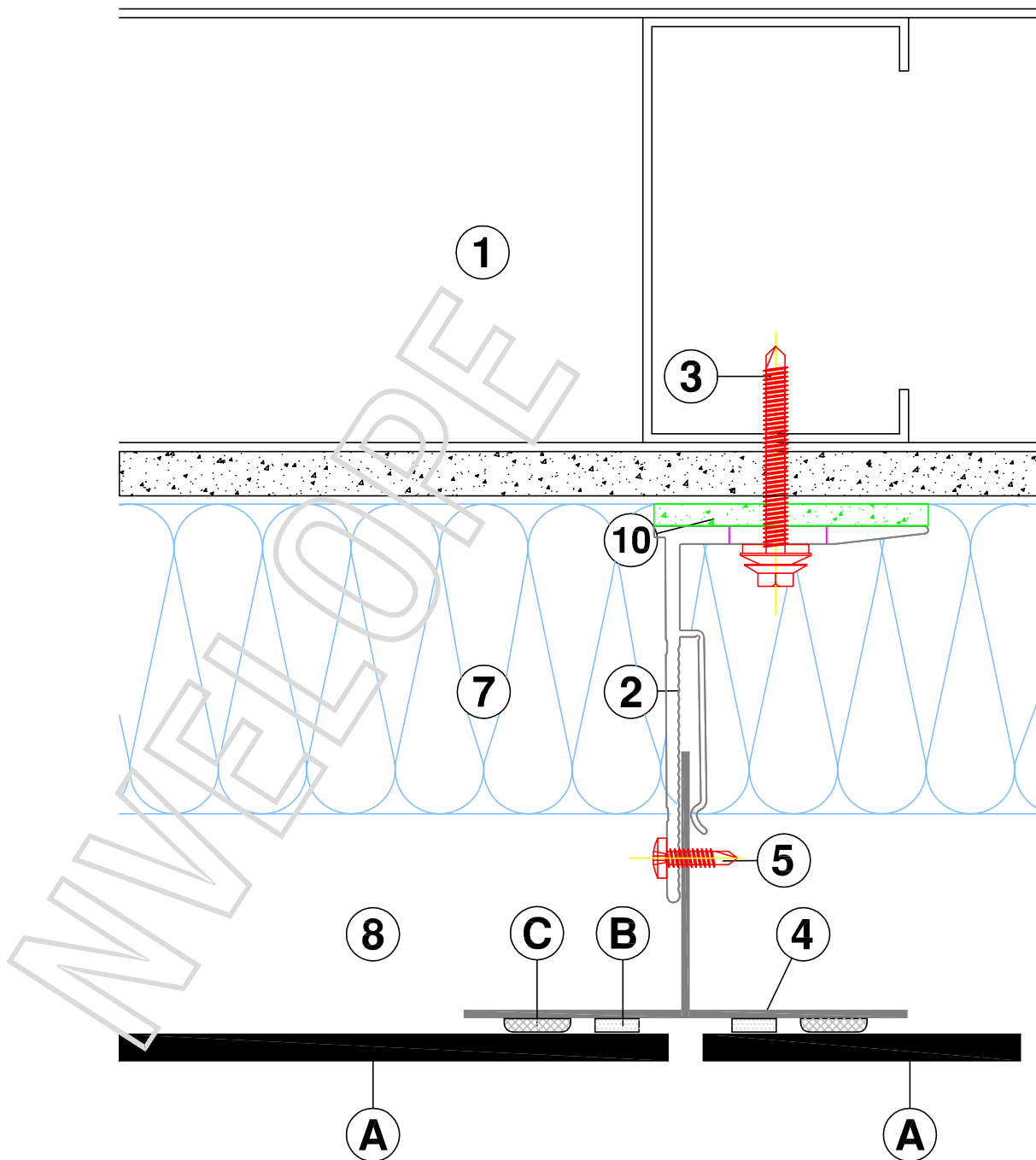

HORIZONTAL SECTION - NVELOPE 90

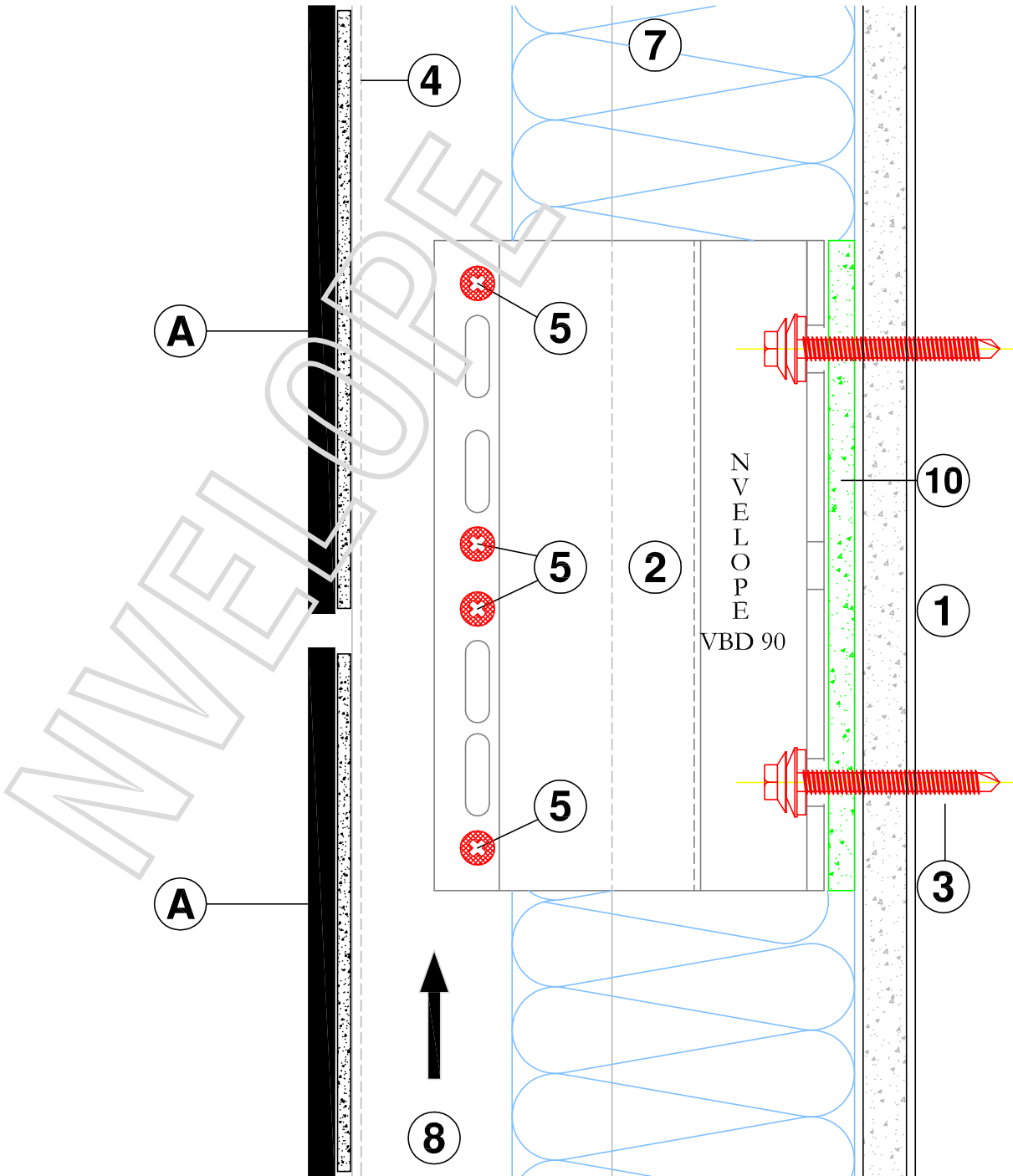

VERTICAL SECTION - NVELOPE VBD 90 FIXED POINT

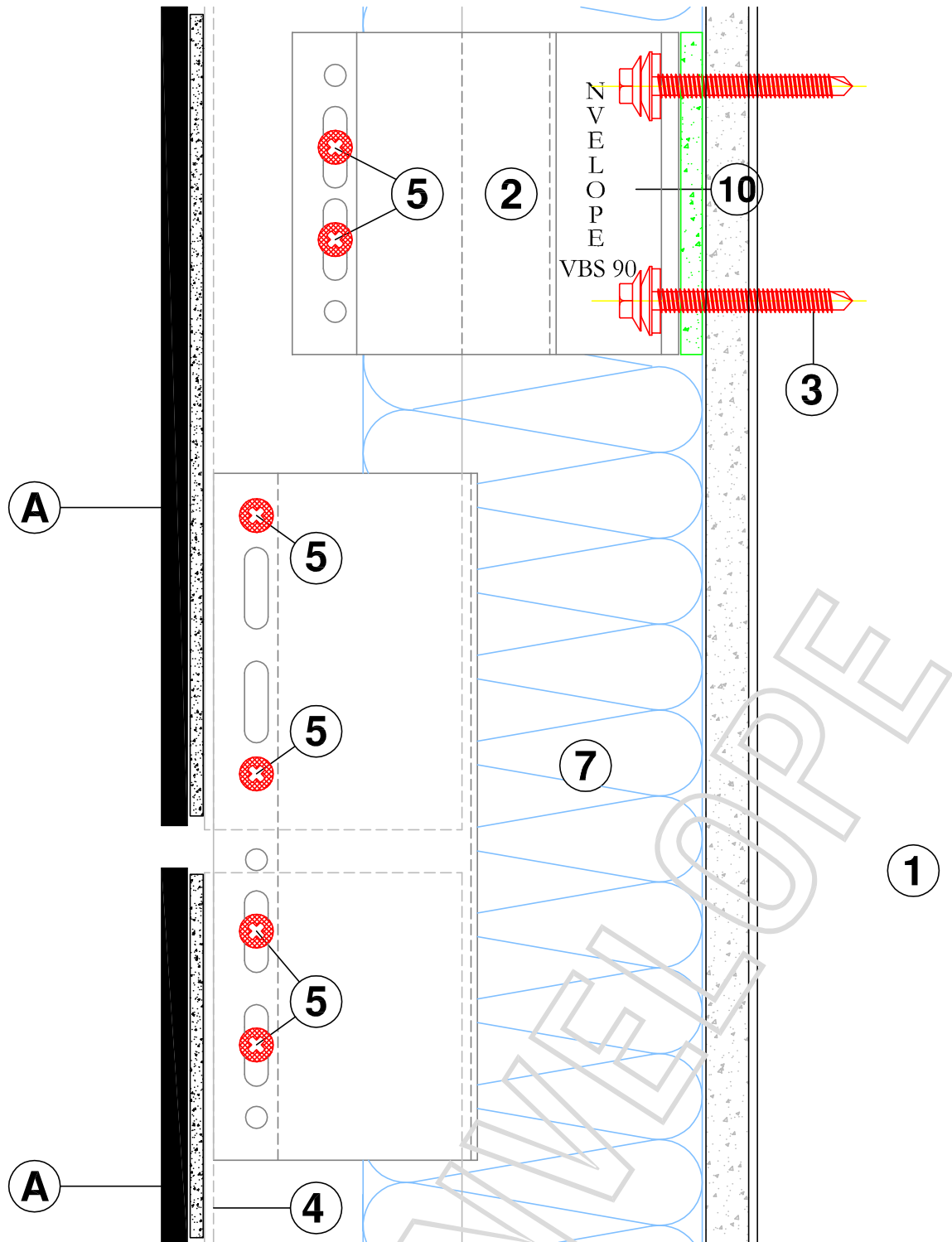

VERTICAL SECTION - RAIL JOINT OF PROFILE

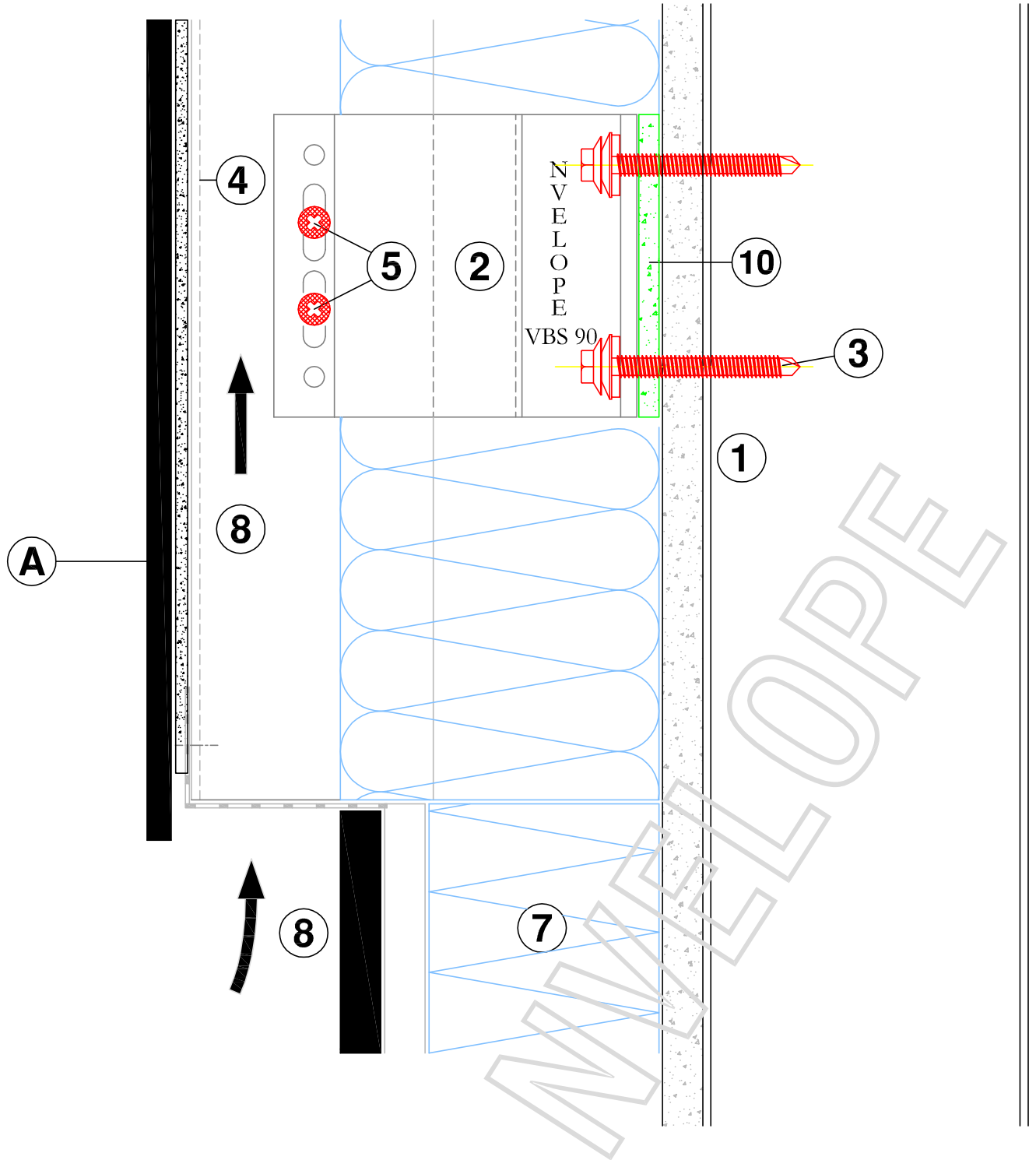

VERTICAL SECTION - BASE OF CLADDING

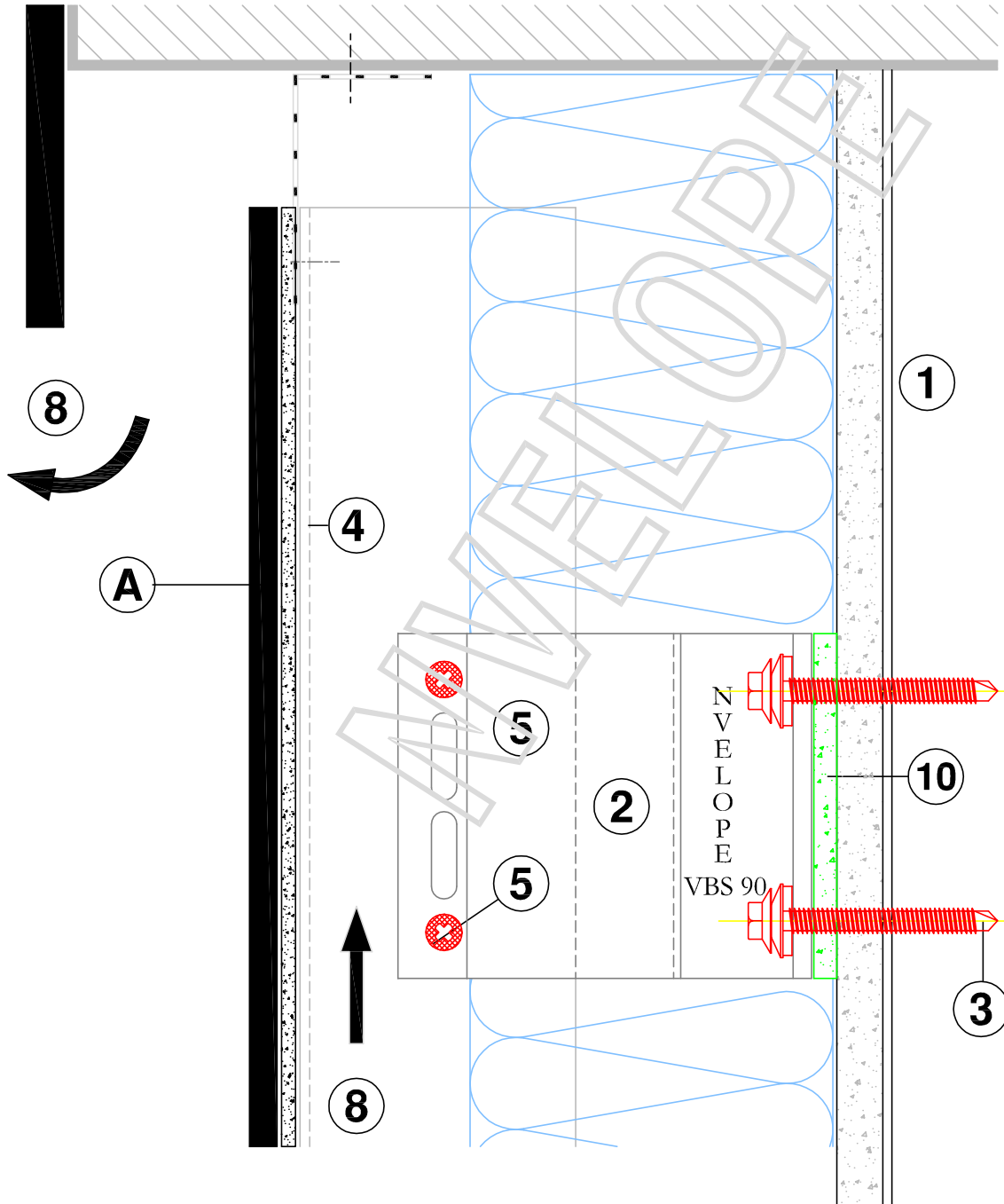

VERTICAL SECTION - TOP OF CLADDING



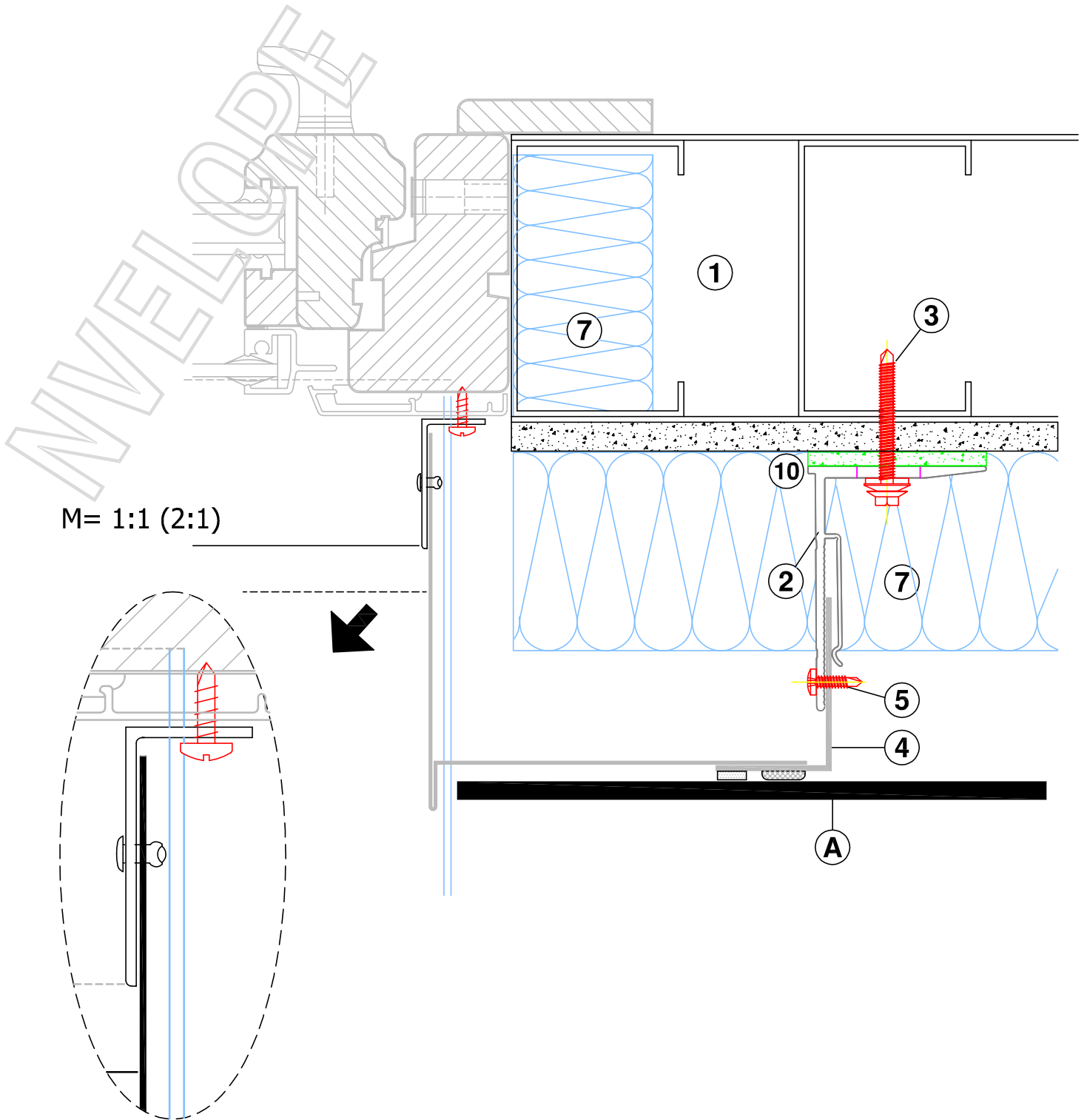

HORIZONTAL SECTION - WINDOW JAMB DETAIL

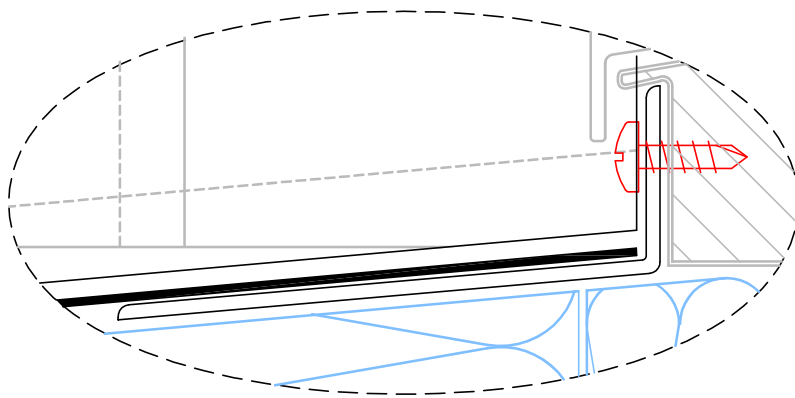

M= 1:1 (2:1)

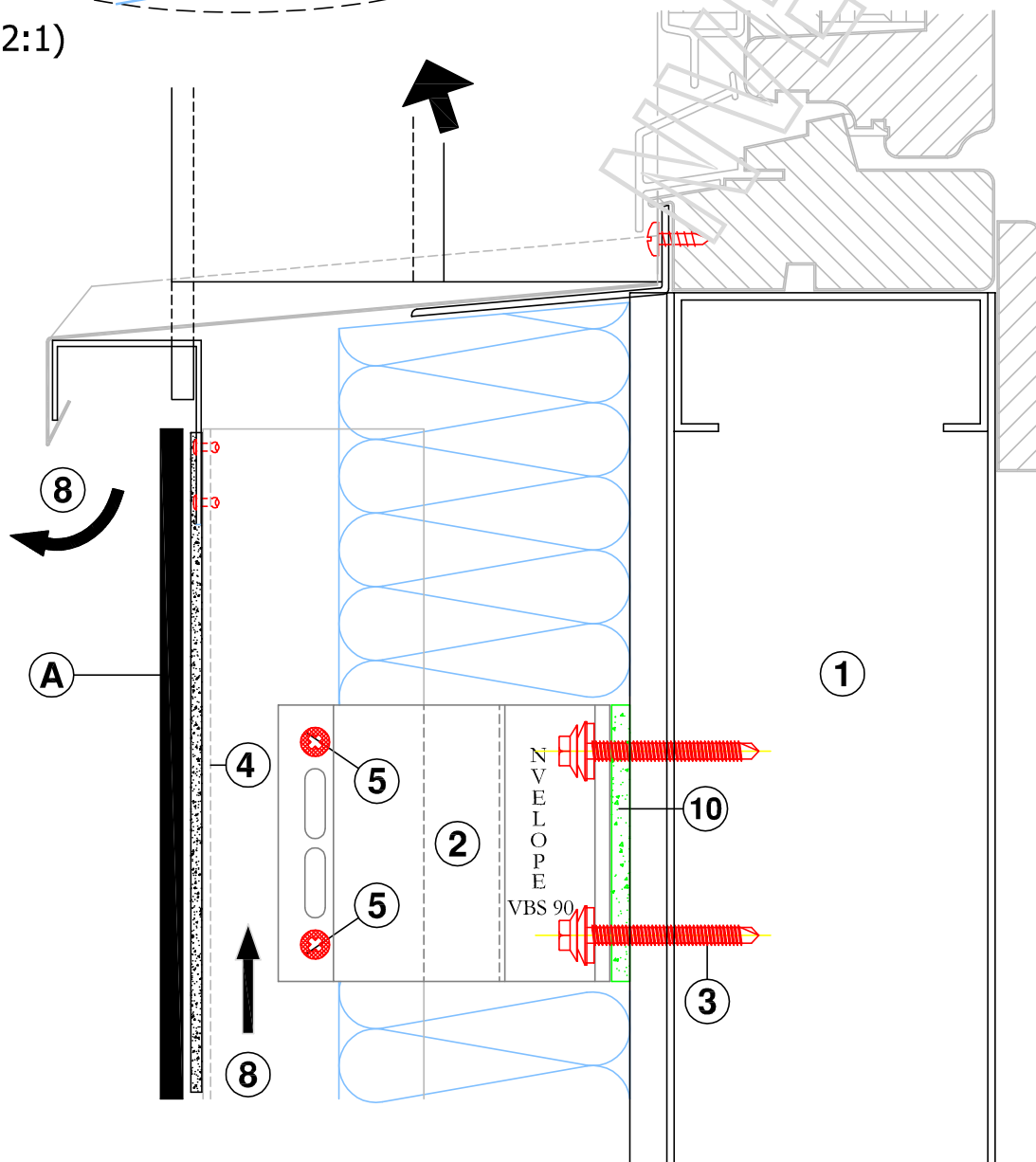

VERTICAL SECTION - WINDOW SILL DETAIL

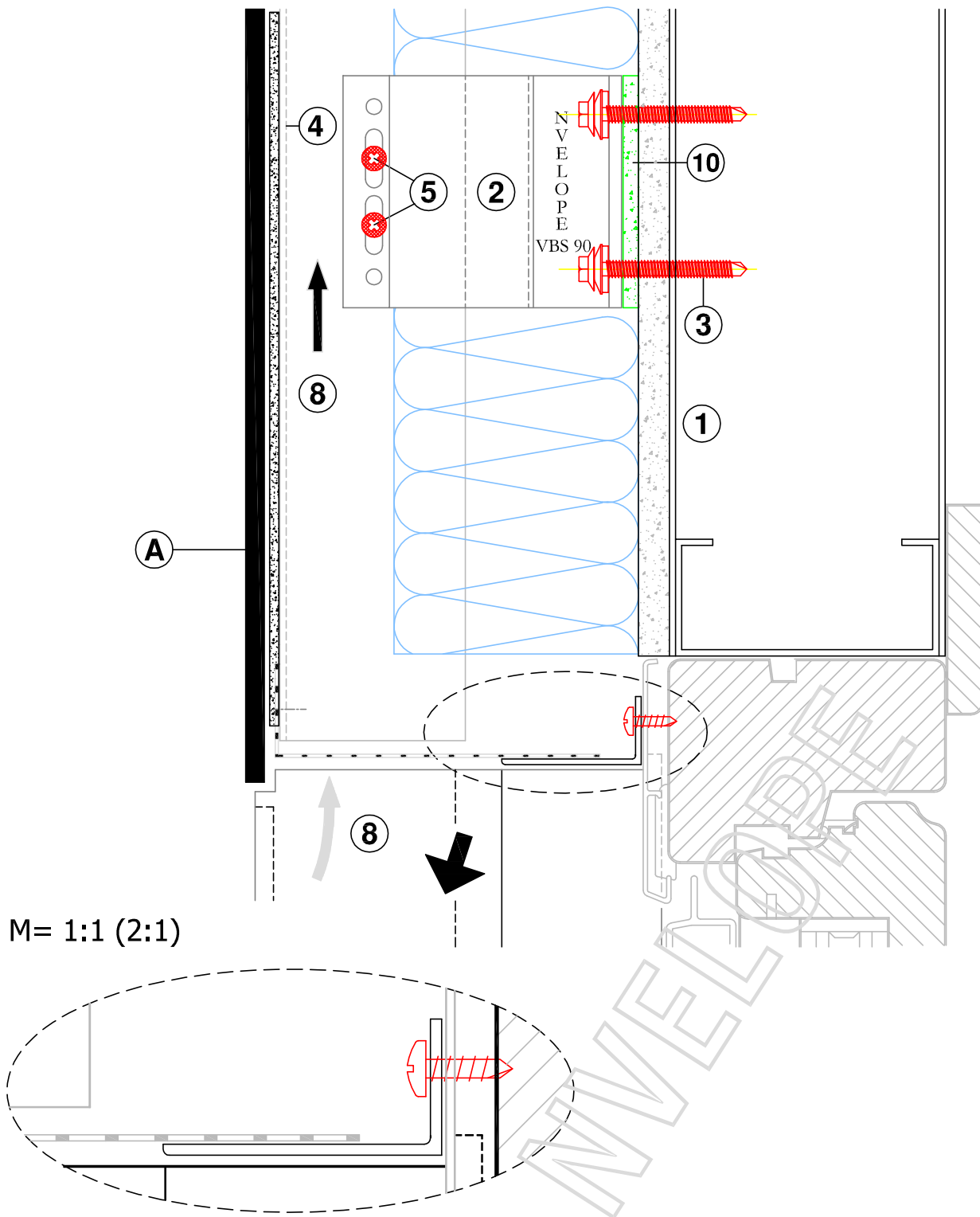

VERTICAL SECTION - WINDOW HEAD DETAIL

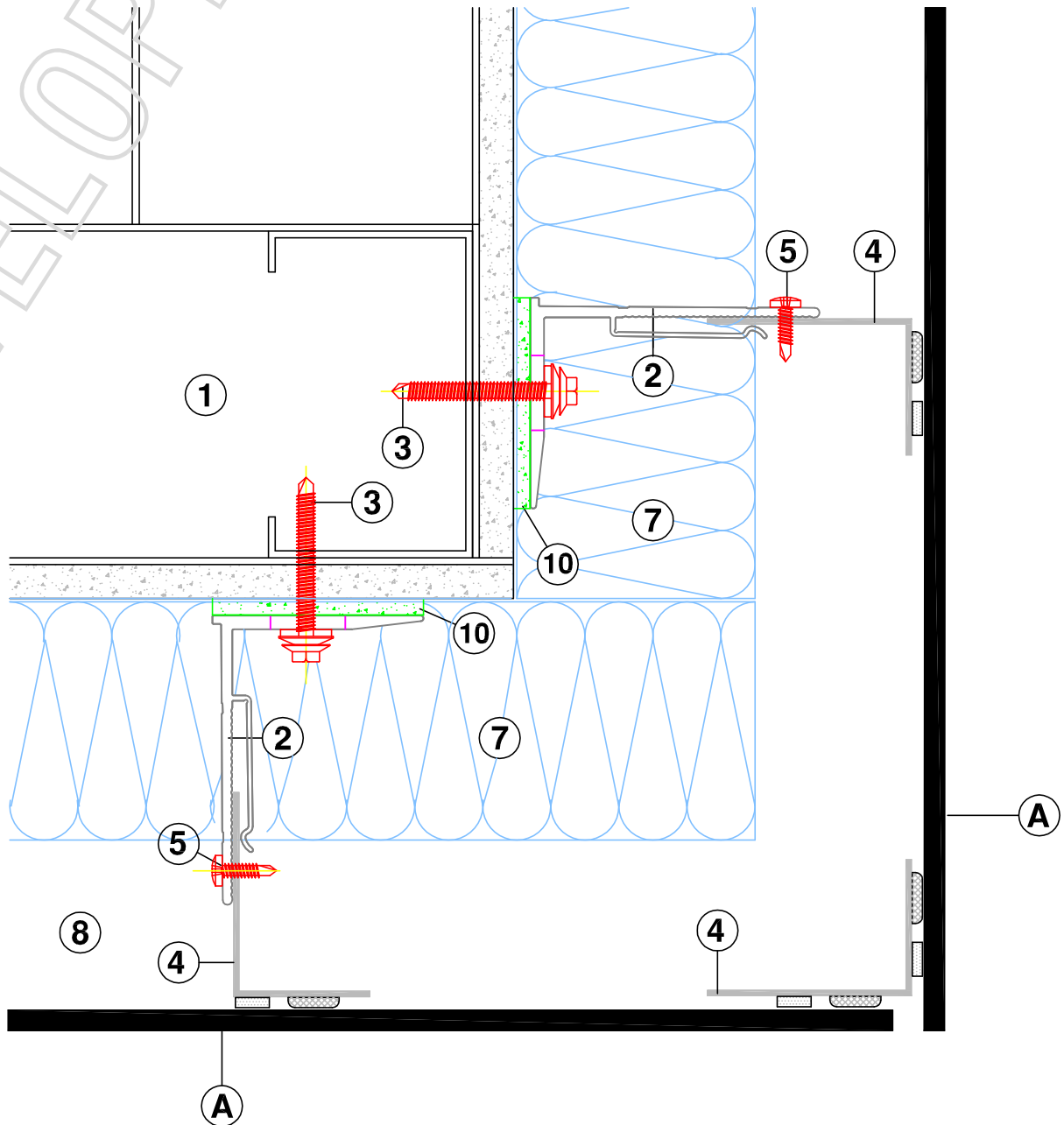

HORIZONTAL SECTION - EXTERNAL CORNER

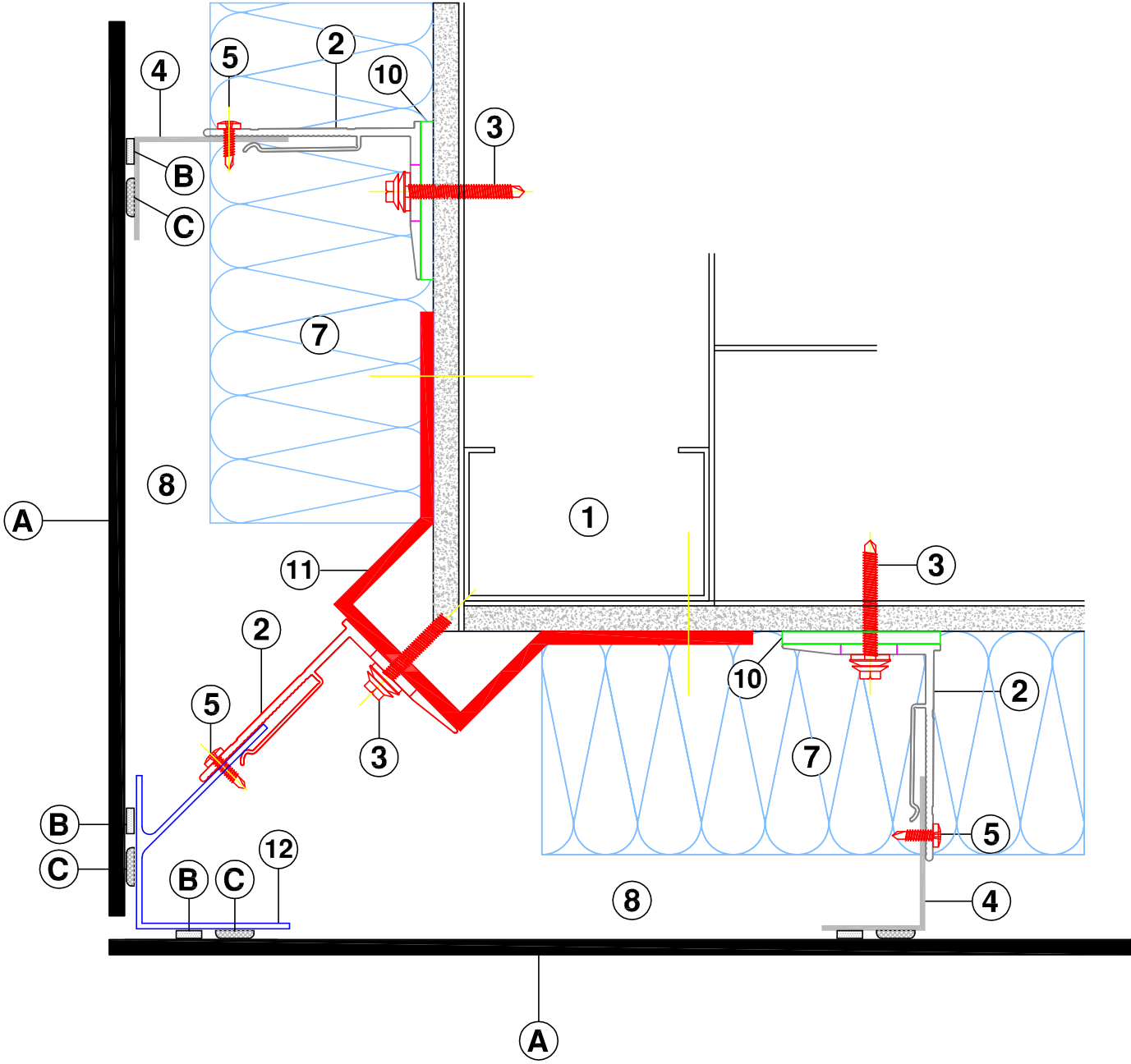

HORIZONTAL SECTION - EXTERNAL CORNER - WITH CORNER BRACKET

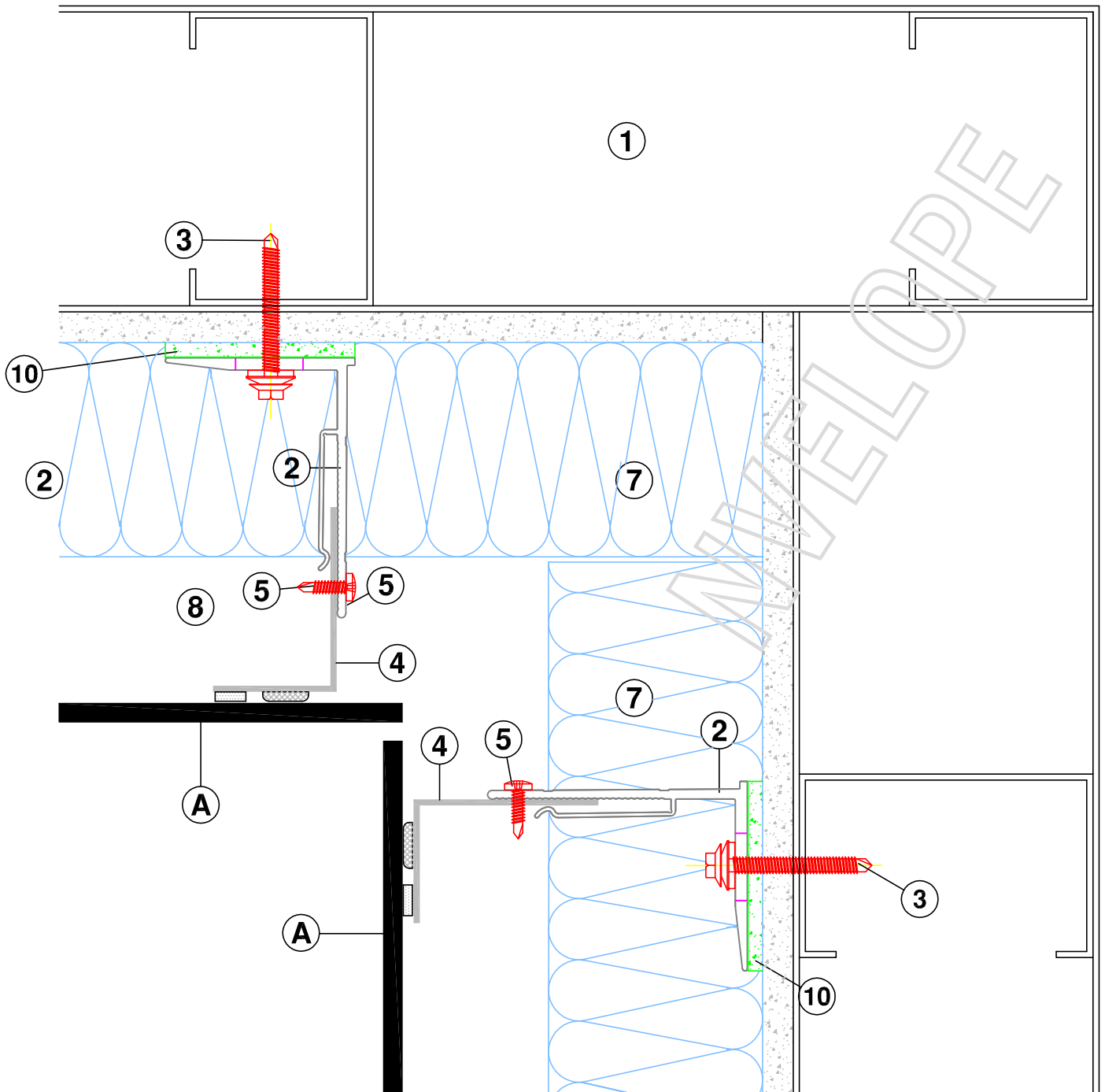

HORIZONTAL SECTION - INTERNAL CORNER